

VIPA System MICRO

SM-DIO | | Manual

HB400 | SM-DIO | | en | 17-30

Digital signal modules - SM M2x



VIPA GmbH
Ohmstr. 4
91074 Herzogenaurach
Telephone: 09132-744-0
Fax: 09132-744-1864
Email: info@vipa.com
Internet: www.vipa.com

Table of contents

1	General	4
	1.1 Copyright © VIPA GmbH	4
	1.2 About this manual.....	5
	1.3 Safety information.....	6
2	Basics and mounting	7
	2.1 Safety information for users.....	7
	2.2 System conception.....	8
	2.3 Dimensions.....	9
	2.4 Mounting.....	10
	2.4.1 Mounting CPU.....	10
	2.4.2 Mounting the extension module.....	13
	2.4.3 Mounting periphery module.....	14
	2.5 Wiring.....	15
	2.5.1 Wiring CPU.....	15
	2.5.2 Wiring periphery module.....	19
	2.6 Demounting.....	20
	2.6.1 Demounting CPU.....	20
	2.6.2 Demounting the extension module.....	24
	2.6.3 Demounting periphery module.....	25
	2.7 Installation guidelines.....	28
	2.8 General data.....	30
3	Digital in-/output	32
	3.1 M21-1BH00 - DI 16xDC 24V.....	32
	3.1.1 Technical data.....	35
	3.2 M22-1BH00 - DO 16xDC 24V 0.5A.....	37
	3.2.1 Diagnostic data.....	39
	3.2.2 Technical data.....	41
	3.3 M22-1HF10 - DO 8xRelay.....	43
	3.3.1 Technical data.....	46
	3.4 M23-1BH00 - DI8/DO8 0.5A.....	48
	3.4.1 Diagnostic data.....	50
	3.4.2 Technical data.....	52

1 General

1.1 Copyright © VIPA GmbH

All Rights Reserved

This document contains proprietary information of VIPA and is not to be disclosed or used except in accordance with applicable agreements.

This material is protected by the copyright laws. It may not be reproduced, distributed, or altered in any fashion by any entity (either internal or external to VIPA), except in accordance with applicable agreements, contracts or licensing, without the express written consent of VIPA and the business management owner of the material.

For permission to reproduce or distribute, please contact: VIPA, Gesellschaft für Visualisierung und Prozessautomatisierung mbH Ohmstraße 4, D-91074 Herzogenaurach, Germany

Tel.: +49 9132 744 -0

Fax.: +49 9132 744-1864

E-Mail: info@vipa.de

<http://www.vipa.com>



Every effort has been made to ensure that the information contained in this document was complete and accurate at the time of publishing. Nevertheless, the authors retain the right to modify the information.

This customer document describes all the hardware units and functions known at the present time. Descriptions may be included for units which are not present at the customer site. The exact scope of delivery is described in the respective purchase contract.

CE Conformity Declaration

Hereby, VIPA GmbH declares that the products and systems are in compliance with the essential requirements and other relevant provisions. Conformity is indicated by the CE marking affixed to the product.

Conformity Information

For more information regarding CE marking and Declaration of Conformity (DoC), please contact your local VIPA customer service organization.

Trademarks

VIPA, SLIO, System 100V, System 200V, System 300V, System 300S, System 400V, System 500S and Commander Compact are registered trademarks of VIPA Gesellschaft für Visualisierung und Prozessautomatisierung mbH.

SPEED7 is a registered trademark of profichip GmbH.

SIMATIC, STEP, SINEC, TIA Portal, S7-300 and S7-400 are registered trademarks of Siemens AG.

Microsoft and Windows are registered trademarks of Microsoft Inc., USA.

Portable Document Format (PDF) and Postscript are registered trademarks of Adobe Systems, Inc.

All other trademarks, logos and service or product marks specified herein are owned by their respective companies.

Information product support

Contact your local VIPA Customer Service Organization representative if you wish to report errors or questions regarding the contents of this document. If you are unable to locate a customer service centre, contact VIPA as follows:

VIPA GmbH, Ohmstraße 4, 91074 Herzogenaurach, Germany
Telefax: +49 9132 744-1204
EMail: documentation@vipa.de

Technical support

Contact your local VIPA Customer Service Organization representative if you encounter problems with the product or have questions regarding the product. If you are unable to locate a customer service centre, contact VIPA as follows:

VIPA GmbH, Ohmstraße 4, 91074 Herzogenaurach, Germany
Tel.: +49 9132 744-1150 (Hotline)
EMail: support@vipa.de

1.2 About this manual

- Target audience** The manual is targeted at users who have a background in automation technology.
- Structure of the manual** The manual consists of chapters. Every chapter provides a self-contained description of a specific topic.
- Guide to the document** The following guides are available in the manual:
- An overall table of contents at the beginning of the manual
 - References with page numbers
- Availability** The manual is available in:
- printed form, on paper
 - in electronic form as PDF-file (Adobe Acrobat Reader)
- Icons Headings** Important passages in the text are highlighted by following icons and headings:



DANGER!

Immediate or likely danger. Personal injury is possible.



CAUTION!

Damages to property is likely if these warnings are not heeded.



Supplementary information and useful tips.

1.3 Safety information

Applications conforming with specifications

The system is constructed and produced for:

- communication and process control
- general control and automation tasks
- industrial applications
- operation within the environmental conditions specified in the technical data
- installation into a cubicle



DANGER!

This device is not certified for applications in

- in explosive environments (EX-zone)

Documentation

The manual must be available to all personnel in the

- project design department
- installation department
- commissioning
- operation



CAUTION!

The following conditions must be met before using or commissioning the components described in this manual:

- Hardware modifications to the process control system should only be carried out when the system has been disconnected from power!
- Installation and hardware modifications only by properly trained personnel.
- The national rules and regulations of the respective country must be satisfied (installation, safety, EMC ...)

Disposal

National rules and regulations apply to the disposal of the unit!

2 Basics and mounting

2.1 Safety information for users

Handling of electrostatic sensitive modules

VIPA modules make use of highly integrated components in MOS-Technology. These components are extremely sensitive to over-voltages that can occur during electrostatic discharges. The following symbol is attached to modules that can be destroyed by electrostatic discharges.



The Symbol is located on the module, the module rack or on packing material and it indicates the presence of electrostatic sensitive equipment. It is possible that electrostatic sensitive equipment is destroyed by energies and voltages that are far less than the human threshold of perception. These voltages can occur where persons do not discharge themselves before handling electrostatic sensitive modules and they can damage components thereby, causing the module to become inoperable or unusable. Modules that have been damaged by electrostatic discharges can fail after a temperature change, mechanical shock or changes in the electrical load. Only the consequent implementation of protection devices and meticulous attention to the applicable rules and regulations for handling the respective equipment can prevent failures of electrostatic sensitive modules.

Shipping of modules

Modules must be shipped in the original packing material.

Measurements and alterations on electrostatic sensitive modules

When you are conducting measurements on electrostatic sensitive modules you should take the following precautions:

- Floating instruments must be discharged before use.
- Instruments must be grounded.

Modifying electrostatic sensitive modules you should only use soldering irons with grounded tips.



CAUTION!

Personnel and instruments should be grounded when working on electrostatic sensitive modules.

2.2 System conception

Overview

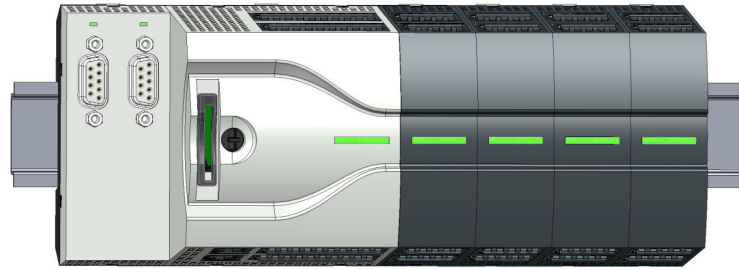

The System MICRO is a modular automation system for assembly on a 35mm mounting rail. By means of periphery modules this system may be adapted matching to your automation tasks. In addition, it is possible to expand your CPU by appropriate interfaces. The wiring complexity is low, because the DC 24V electronic section supply is integrated to the backplane bus and defective modules may be replaced with standing wire.

Components

- CPU
- Extension module
- Periphery module

CPU

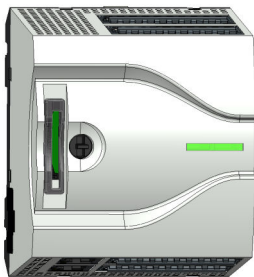

With the CPU electronic, input/output components and power supply are integrated to one casing. In addition, up to 8 periphery modules of the System MICRO can be connected to the backplane bus. As head module via the integrated power module for power supply CPU electronic and the I/O components are supplied as well as the electronic of the periphery modules, which are connected via backplane bus. To connect the power supply of the I/O components and for DC 24V electronic power supply of the periphery modules, which are connected via backplane bus, the CPU has removable connectors. By installing of up to 8 periphery modules at the backplane bus of the CPU, these are electrically connected, this means these are assigned to the backplane bus and connected to the DC 24V electronic power supply.

Extension module



By using extension modules you can extend the interfaces of the CPU. The attachment to the CPU is made by plugging on the left side of the CPU. You can only connect one extension module to the CPU at a time.

Periphery module



By means of up to 8 periphery modules, you can extend the internal I/O areas. The attachment to the CPU is made by plugging them on the right side of the CPU.

2.3 Dimensions

Dimensions CPU M13C

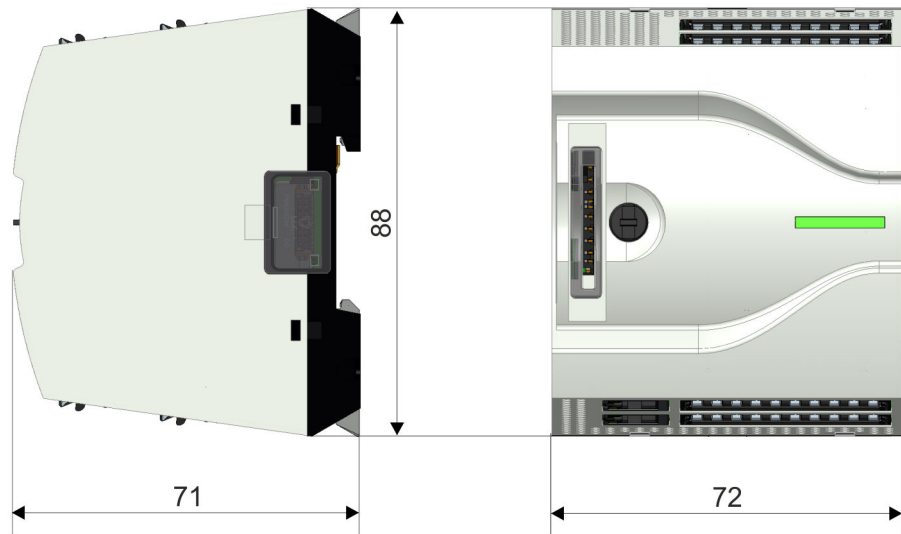

Dimensions in mm

Dimensions extension module EM M09

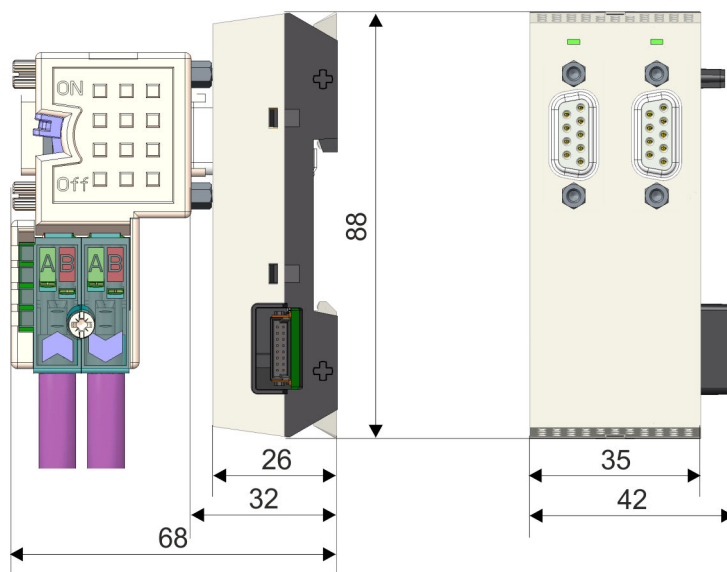

Dimensions in mm

Dimensions periphery module SM Mxx

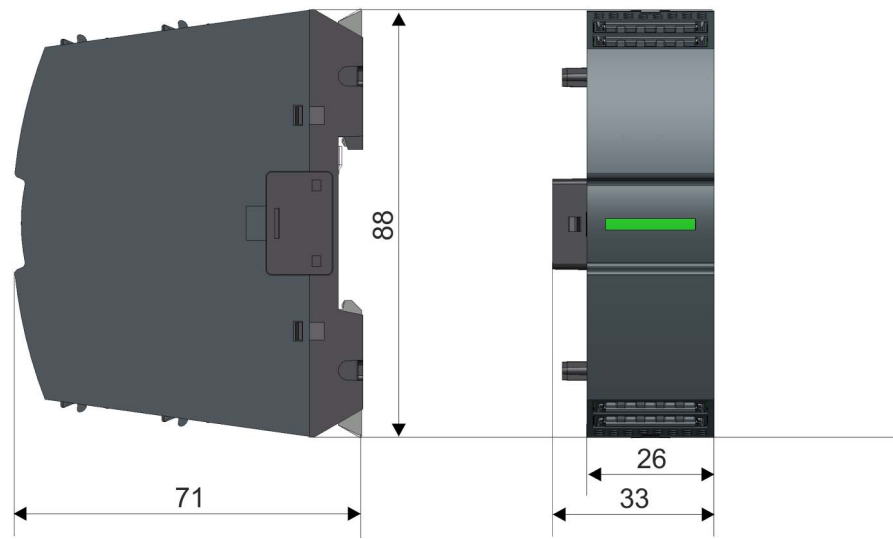

Dimensions in mm

2.4 Mounting

2.4.1 Mounting CPU

2.4.1.1 Mounting CPU without mounting rail



CAUTION!

Mounting without mounting rail is only permitted, if you only want to use the CPU without extension and periphery modules. Otherwise, a mounting rail must always be used for EMC technical reasons.

Proceeding

You can screw the CPU to the back wall by means of screws via the locking levers. The happens with the following proceeding:

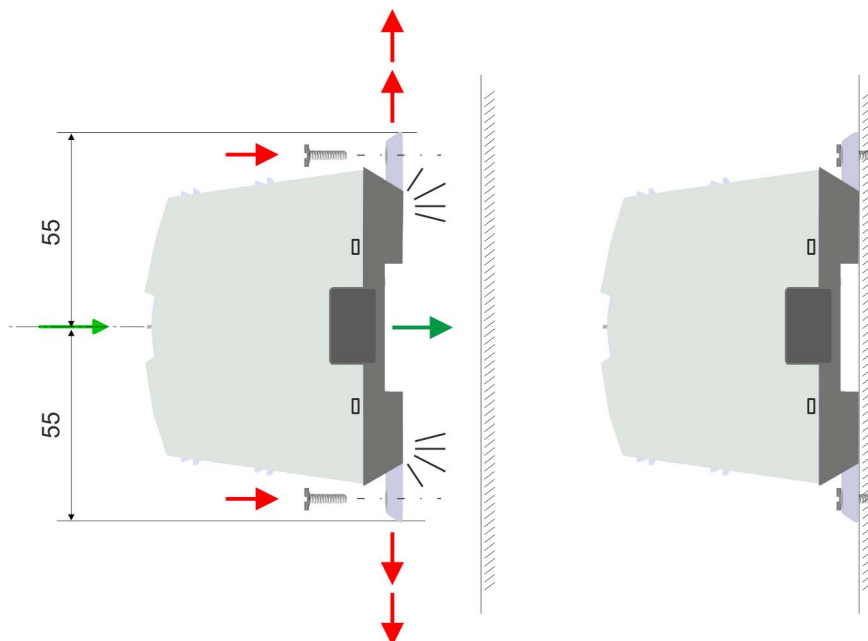

Dimensions in mm

1. ➤ The CPU has a locking lever on the upper and lower side. Pull these levers outwards as shown in the figure, until these engage 2x audible.
 - ⇨ By this openings on the locking levers get visible.
2. ➤ Use the appropriate screws to fix your CPU to your back wall. Consider the installation clearances for the CPU.
 - ⇨ The CPU is now mounted and can be wired.

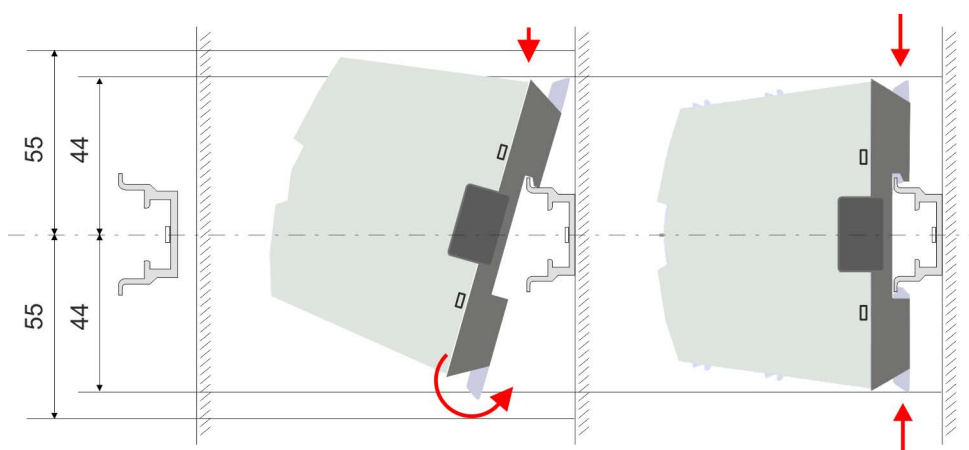
2.4.1.2 Mounting with mounting rail**Proceeding**

Dimensions in mm

1. ➤ Mount the mounting rail. Please consider that a clearance from the middle of the mounting rail of at least 44mm respectively 55mm above and below exists.

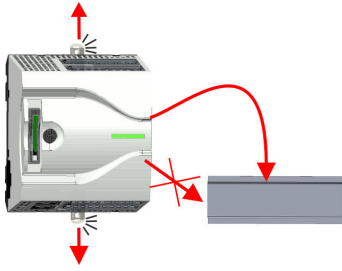

2. The CPU has a locking lever on the upper and lower side. Pull these levers outwards as shown in the figure, until these engage audible.



CAUTION!

It is not allowed to mount the module sideways on the mounting rail, as otherwise the module may be damaged.

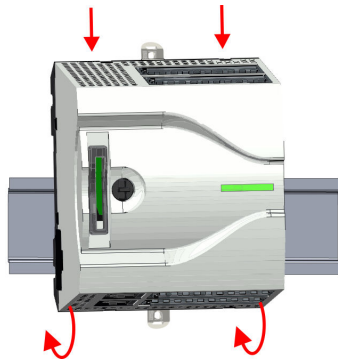

3. Plug the CPU from the top onto the mounting rail and turn the periphery module downward until it rests on the mounting rail.

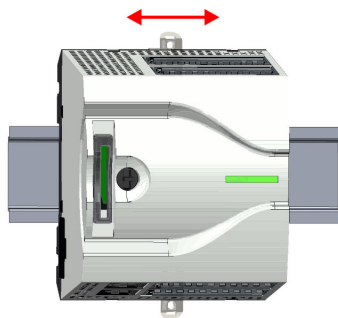

4. Move the CPU on the mounting rail at its position.

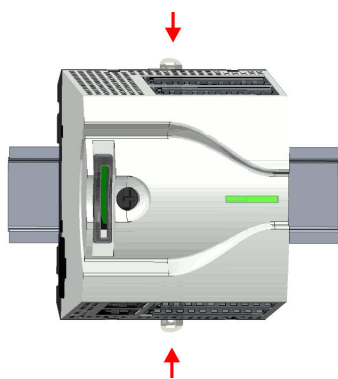

5. To fix the CPU at the mounting rail, move the locking levers back to the initial position.

⇒ The CPU is now mounted and can be wired.

2.4.2 Mounting the extension module

Proceeding

You have the possibility to extend the interfaces of the CPU by plugging an extension module. For this the extension module is plugged at the left side of the CPU. The mountings happens with the following proceeding:

1. ➤ Remove the bus cover with a screwdriver on the left side of the CPU.

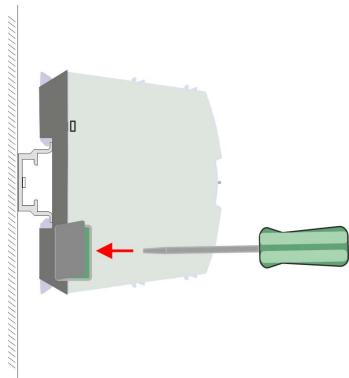

2. ➤ The extension module has a locking lever on the upper and lower side. Pull these levers outwards as shown in the figure, until these engage audible.

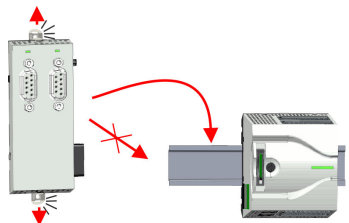

CAUTION!

It is not allowed to mount the module sideways on the mounting rail, as otherwise the module may be damaged.

3. ➤ To mount plug the extension module from the top onto the mounting rail and turn the extension module downward until it rests on the mounting rail.

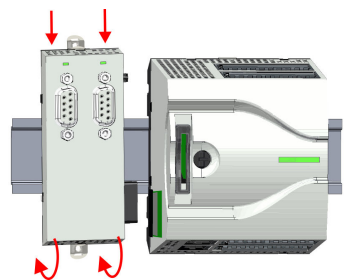

4. ➤ Attach the extension module to the CPU by sliding the extension module on the mounting rail to the right until the interface connector slightly locks into the CPU.

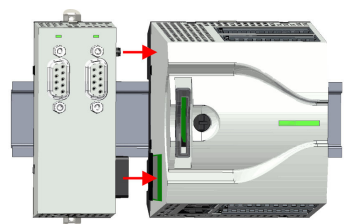

5. ➤ To fix the extension module at the mounting rail, move the locking levers back to the initial position.

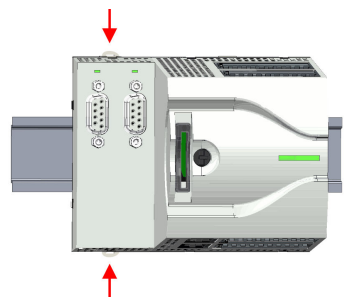

2.4.3 Mounting periphery module

Proceeding

You have the possibility to extend the periphery area of the CPU by plugging up to 8 periphery modules. For this the periphery modules are plugged at the right side of the CPU. The mountings happens with the following proceeding:

1. ➤ Remove the bus cover with a screwdriver on the right side of the CPU.

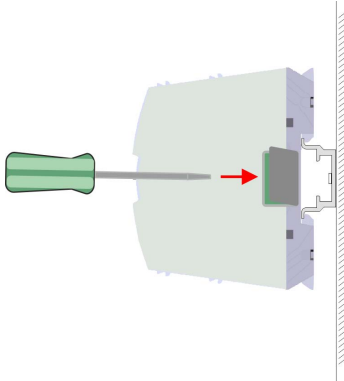

2. ➤ Each periphery module has a locking lever on its upper and lower side. Pull these levers outwards as shown in the figure, until these engage audible.

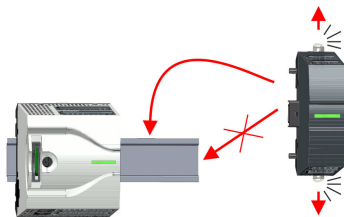

CAUTION!

It is not allowed to mount the module sideways on the mounting rail, as otherwise the module may be damaged.

3. ➤ To mount plug the periphery module from the top onto the mounting rail and turn the periphery module downward until it rests on the mounting rail.

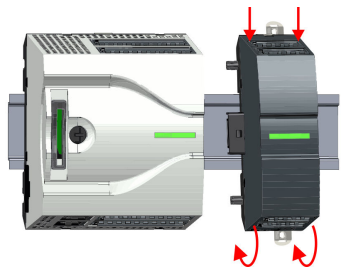

4. ➤ Attach the periphery module to the CPU by sliding the periphery module on the mounting rail to the left until the interface connector slightly locks into the CPU.

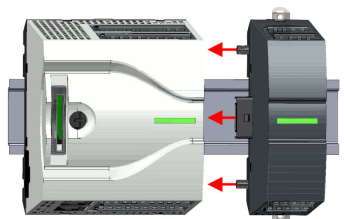

5. ➤ To fix the periphery module at the mounting rail, move the locking levers back to the initial position.

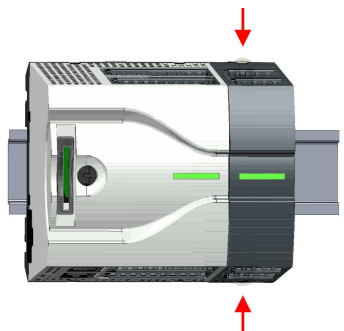

6. ➤ Proceed in this way with additional periphery modules.

2.5 Wiring



CAUTION!

Consider temperature for external cables!

Cables may experience temperature increase due to system heat dissipation. Thus the cabling specification must be chosen 5°C above ambient temperature!



CAUTION!

Separate insulation areas!

The system is specified for SELV/PELV environment. Devices, which are attached to the system must meet these specifications. Installation and cable routing other than SELV/PELV specification must be separated from the system's equipment!

2.5.1 Wiring CPU

CPU connector

For wiring the CPU has removable connectors. With the wiring of the connectors a "push-in" spring-clip technique is used. This allows a quick and easy connection of your signal and supply lines. The clamping off takes place by means of a screwdriver.

Data

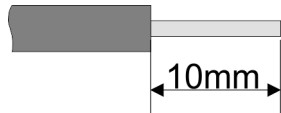

U_{max}	240V AC / 30V DC
I_{max}	10A
Cross section	0.2 ... 1.5mm ² (AWG 24 ... 16)
Stripping length	10mm

Use for wiring rigid wires respectively use wire sleeves. When using stranded wires you have to press the release button with a screwdriver during the wiring.

Wiring procedure

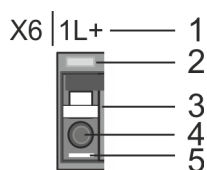

- 1 Labeling on the casing
- 2 Status LED
- 3 Release area
- 4 Connection hole for wire
- 5 Pin 1 of the connector is labelled by a white line

Insert wire

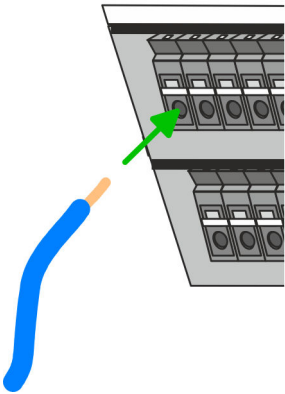

The wiring happens without a tool.

- ➔ Determine according to the casing labelling the connection position and insert through the round connection hole of the according contact your prepared wire until it stops, so that it is fixed.
- ➔ By pushing the contact spring opens, thus ensuring the necessary contact pressure.

Remove wire

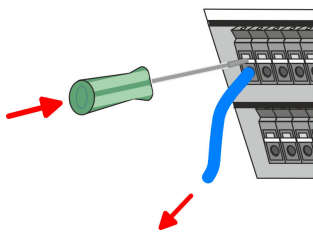

The wire is to be removed by means of a screwdriver with 2.5mm blade width.

1. ➔ Press with your screwdriver vertically at the release button.
 - ➔ The contact spring releases the wire.
2. ➔ Pull the wire from the round hole.

Standard wiring

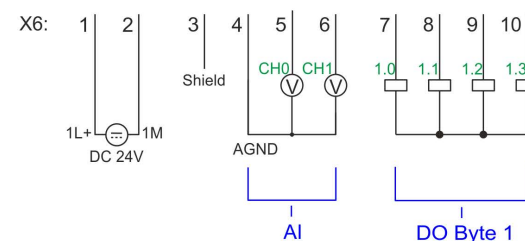
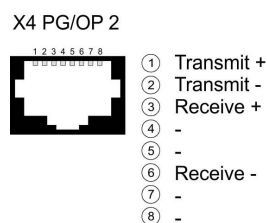
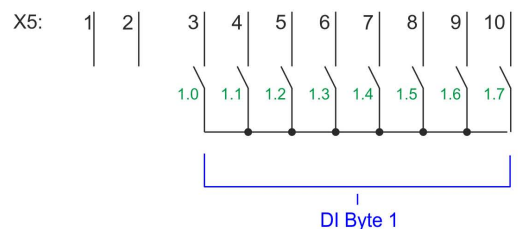
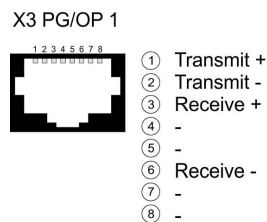
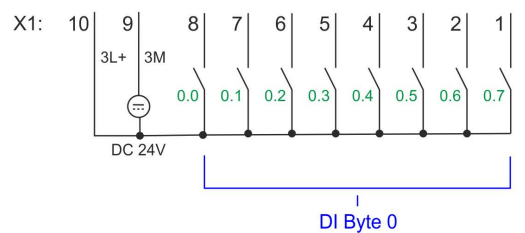
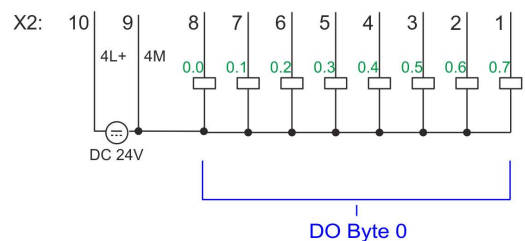
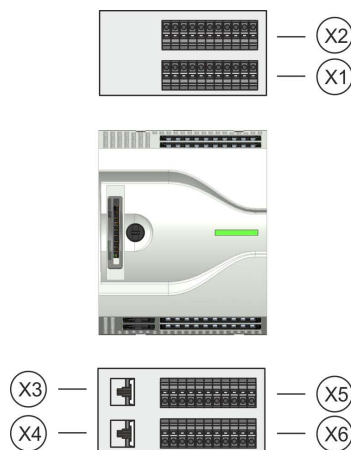

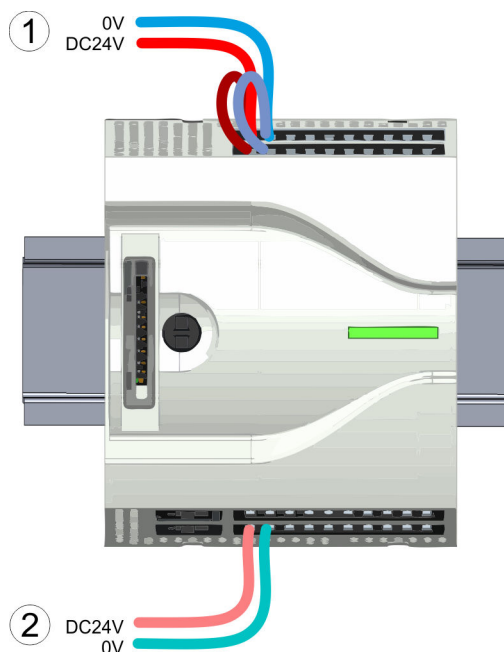

- (1) X2: 4L+: DC 24V power section supply for integrated outputs
 X1: 3L+: DC 24V power section supply for integrated inputs
- (2) X6: 1L+ DC 24V for electronic power supply



The electronic power section supply is internally protected against higher voltage by fuse. The fuse is located inside the CPU and can not be changed by the user.

Fusing

- It is recommended to externally protect the electronic power supply for CPU and backplane bus with a 3A fuse (fast) respectively by a line circuit breaker 3A characteristics Z.
- The power section supply of the internal I/Os is to be externally protected with a 6A fuse (fast) respectively by a line circuit breaker 6A characteristics Z.

Remove connector

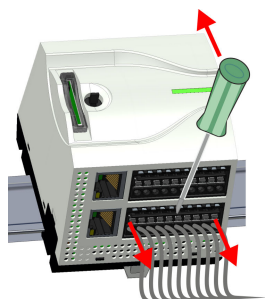

By means of a screwdriver there is the possibility to remove the connectors e.g. for module exchange with a fix wiring. For this each connector has indentations for unlocking at the top. Unlocking takes place by the following proceeding:

- 1.** → Remove connector:

Insert your screwdriver from above into one of the indentations.

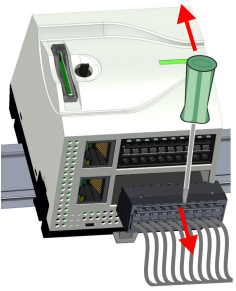

2. → Push the screwdriver backwards:
 - ⇒ The connector is unlocked and can be removed.

**CAUTION!**

Via wrong operation such as pressing, the screwdriver downward the release lever may be damaged.

3. → Plug connector:
The connector is plugged by plugging it directly into the release lever.

2.5.2 Wiring periphery module

Periphery module connector

For wiring the periphery module has removable connectors. With the wiring of the connectors a "push-in" spring-clip technique is used. This allows a quick and easy connection of your signal and supply lines. The clamping off takes place by means of a screwdriver.

Data

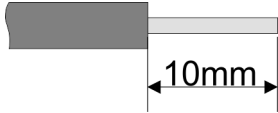

U_{max}	240V AC / 30V DC
I_{max}	10A
Cross section	0.2 ... 1.5mm ² (AWG 24 ... 16)
Stripping length	10mm

Use for wiring rigid wires respectively use wire sleeves. When using stranded wires you have to press the release button with a screwdriver during the wiring.

Wiring procedure

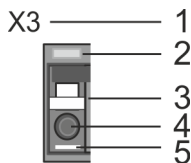

- 1 Labeling on the casing
- 2 Status LED
- 3 Release area
- 4 Connection hole for wire
- 5 Pin 1 of the connector is labelled by a white line

Insert wire

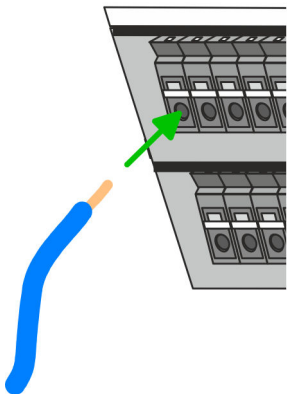

The wiring happens without a tool.

- ➔ Determine according to the casing labelling the connection position and insert through the round connection hole of the according contact your prepared wire until it stops, so that it is fixed.
 - ⇒ By pushing the contact spring opens, thus ensuring the necessary contact pressure.

Remove wire

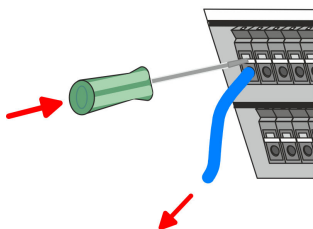

The wire is to be removed by means of a screwdriver with 2.5mm blade width.

1. ➔ Press with your screwdriver vertically at the release button.
 - ⇒ The contact spring releases the wire.
2. ➔ Pull the wire from the round hole.

Remove connector

By means of a screwdriver there is the possibility to remove the connectors e.g. for module exchange with a fix wiring. For this each connector has indentations for unlocking at the top. Unlocking takes place by the following proceeding:

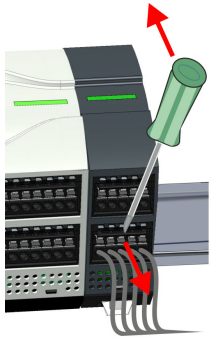

1. ➤ Remove connector:

Insert your screwdriver from above into one of the indentations.

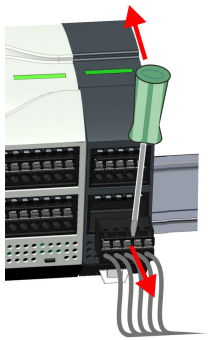

2. ➤ Push the screwdriver backwards:

⇒ The connector is unlocked and can be removed.



CAUTION!

Via wrong operation such as pressing, the screwdriver downward the release lever may be damaged.

3. ➤ Plug connector:

The connector is plugged by plugging it directly into the release lever.

2.6 Demounting

2.6.1 Demounting CPU

Remove connector

By means of a screwdriver there is the possibility to remove the connectors e.g. for module exchange with a fix wiring. For this each connector has indentations for unlocking at the top. Unlocking takes place by the following proceeding:

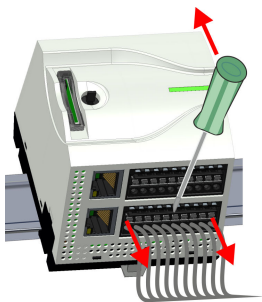

1. ➤ Power-off your system.

2. ➤ Remove connector:

Insert your screwdriver from above into one of the indentations.

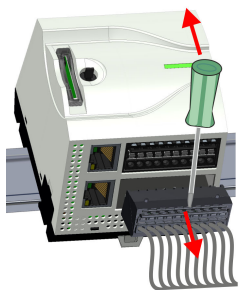

3. ➤ Push the screwdriver backwards:
 - ⇒ The connector is unlocked and can be removed.



CAUTION!

Via wrong operation such as pressing, the screwdriver downward the connector may be damaged!

4. ➤ In this way, remove all plugged connectors on the CPU.

CPU replacement (stand-alone)

If more modules are connected to the CPU ↪ 'Option: CPU replacement in a system' on page 23. If no other modules are connected to the CPU, the CPU is replaced according to the following proceeding:

1. ➤ Use a screwdriver to pull the locking levers of the CPU outwards until these engage audibly.

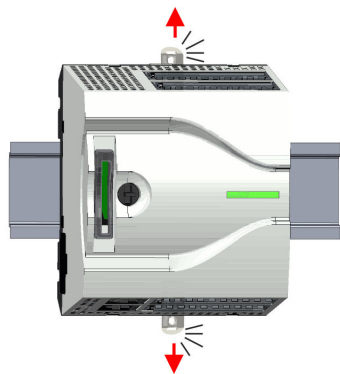

2. ➤ Remove the CPU with a rotation upwards from the mounting rail.

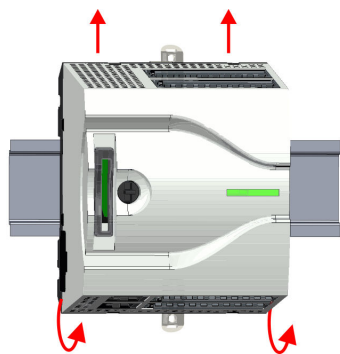

3. ➤ Pull the locking levers of the CPU outwards until these engage audibly.



CAUTION!

It is not allowed to mount the module sideways on the mounting rail, as otherwise the module may be damaged!

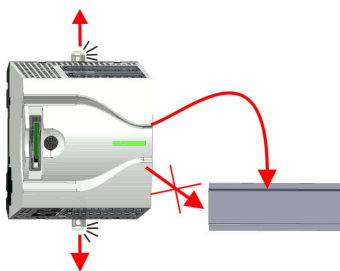

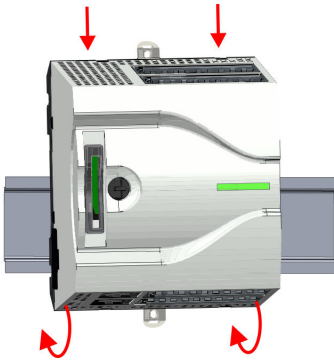

4. Plug the CPU from the top onto the mounting rail and turn the periphery module downward until it rests on the mounting rail.

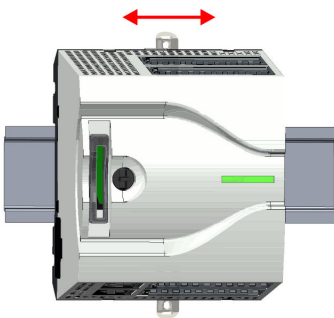

5. Move the CPU on the mounting rail at its position.

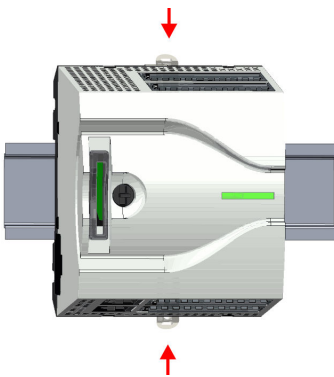

6. To fix the CPU at the mounting rail, move the locking levers back to the initial position.

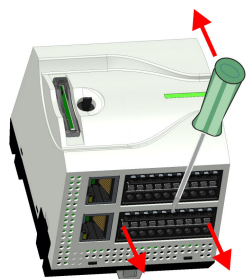

7. Remove the connectors, which are not necessary at the CPU.

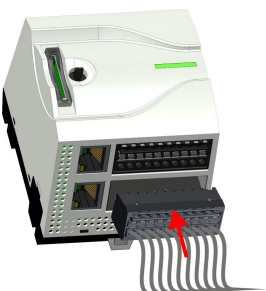

8. Plug again the wired connectors.
 ⇒ Now you can bring your system back into operation.

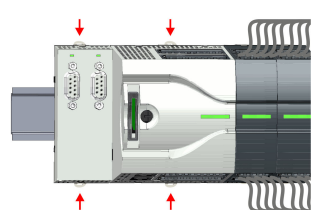
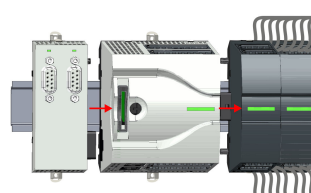
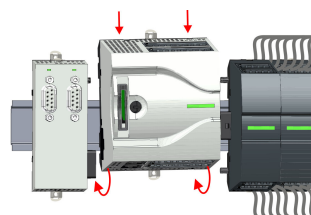
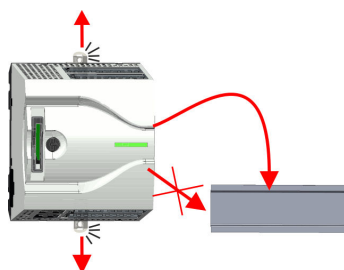
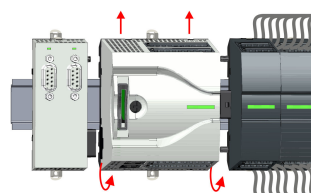
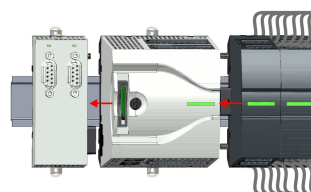
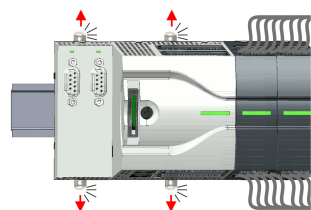
Option: CPU replacement in a system

In the following the replacement of a CPU in a system is shown:

1. ➤ If there is an extension module connected to the CPU, you have to remove it from the CPU. For this use a screwdriver to pull the locking levers of the extension module and CPU outwards until these engage audibly.

2. ➤ Disconnect all the modules, which are connected to the CPU by moving the CPU along with the extension module on the mounting rail.

3. ➤ Remove the CPU with a rotation upwards from the mounting rail.

4. ➤ Pull the locking levers of the CPU outwards until these engage audibly.

**CAUTION!**

It is not allowed to mount the module sideways on the mounting rail, as otherwise the module may be damaged!

5. ➤ For mounting pull the locking levers of the CPU outwards until these engage audibly. Plug the CPU from the top onto the mounting rail and turn the periphery module downward until it rests on the mounting rail.

6. ➤ Rebind your modules by moving the CPU along with the extension module on the mounting rail.

7. ➤ To fix the CPU at the mounting rail, move the locking levers back to the initial position.

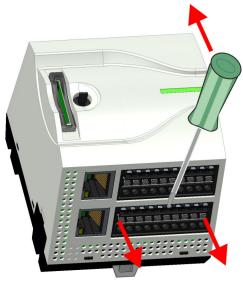

8. ➤ Remove the connectors, which are not necessary at the CPU.

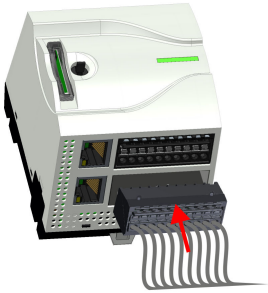

9. ➤ Plug again the wired connectors.

⇒ Now you can bring your system back into operation.

2.6.2 Demounting the extension module

Proceeding

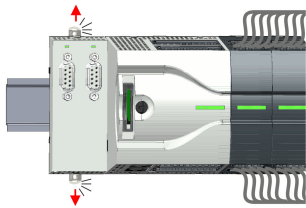

1. ➤ Power-off your system.

2. ➤ Remove the corresponding bus connectors.

3. ➤ Use a screwdriver to pull the locking levers of the extension module outwards until these engage audible.

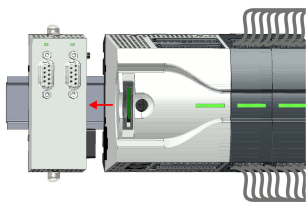

4. ➤ Remove the extension module from the CPU by sliding it on the mounting rail.

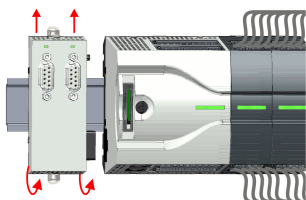

5. ➤ Remove the extension module with a rotation upwards from the mounting rail.

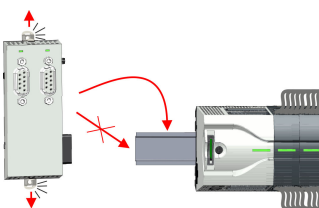

6. ➤ Pull the locking levers of the extension module outwards until these engage audible.



CAUTION!

It is not allowed to mount the module sideways on the mounting rail, as otherwise the module may be damaged!

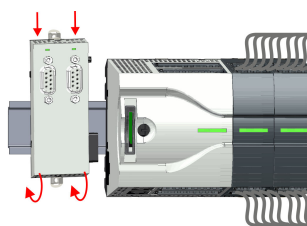

7. Plug the extension module from the top onto the mounting rail and turn the extension module downward until it rests on the mounting rail.

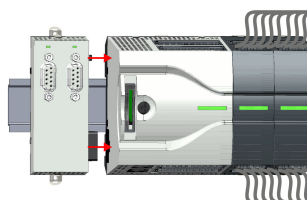

8. Reattach the extension module to the CPU by sliding the extension module on the mounting rail to the right until the interface connector slightly locks into the CPU.

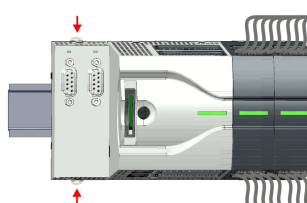

9. Move the locking levers back to the initial position.
 10. Plug the corresponding bus connectors.
 ⇒ Now you can bring your system back into operation.

2.6.3 Demounting periphery module

Remove connector

By means of a screwdriver there is the possibility to remove the connectors e.g. for module exchange with a fix wiring. For this each connector has indentations for unlocking at the top. Unlocking takes place by the following proceeding:

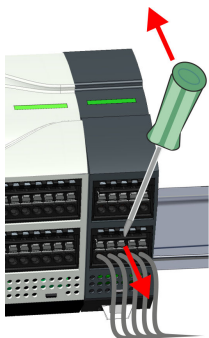

1. Power-off your system.
 2. Remove connector:
 Insert your screwdriver from above into one of the indentations.

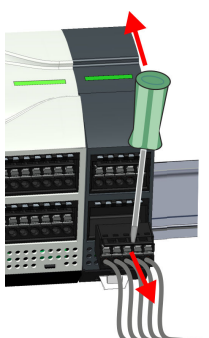

3. Push the screwdriver backwards:
 ⇒ The connector is unlocked and can be removed.



CAUTION!

Via wrong operation such as pressing, the screwdriver downward the connector may be damaged!

4. In this way, remove all plugged connectors on the periphery module.

Replace the periphery module

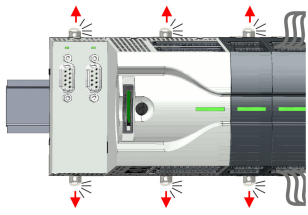

1. ➤ Remove the modules that are connected to the module to be replaced by pulling their release levers outwards until these engage audible ...

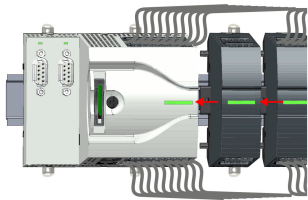

2. ➤ ... and move the modules accordingly.

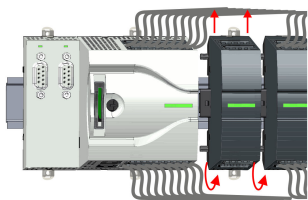

3. ➤ Remove the periphery module with a rotation upwards from the mounting rail.

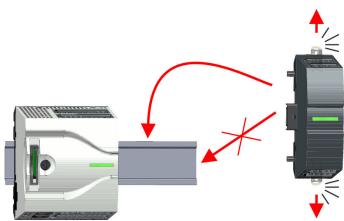

4. ➤ Pull the locking levers outwards until these engage audible.



CAUTION!

It is not allowed to mount the module sideways on the mounting rail, as otherwise the module may be damaged!

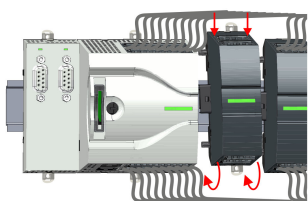

5. ➤ Plug the periphery module from the top onto the mounting rail and turn the periphery module downward until it rests on the mounting rail.

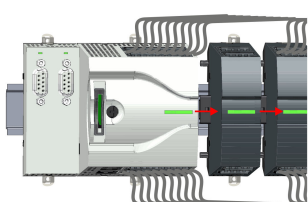

6. ➤ Reconnect all modules by pushing them together again on the mounting rail.

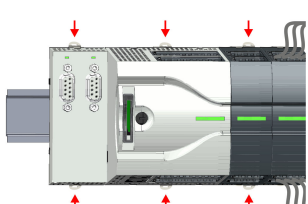

7. ➤ Move the locking levers back to the initial position.



8. → Remove the connectors, which are not necessary.



9. → Plug again the wired connectors.
⇒ Now you can bring your system back into operation.

2.7 Installation guidelines

General

The installation guidelines contain information about the interference free deployment of a PLC system. There is the description of the ways, interference may occur in your PLC, how you can make sure the electromagnetic compatibility (EMC), and how you manage the isolation.

What does EMC mean?

Electromagnetic compatibility (EMC) means the ability of an electrical device, to function error free in an electromagnetic environment without being interfered respectively without interfering the environment.

The components of VIPA are developed for the deployment in industrial environments and meets high demands on the EMC. Nevertheless you should project an EMC planning before installing the components and take conceivable interference causes into account.

Possible interference causes

Electromagnetic interferences may interfere your control via different ways:

- Electromagnetic fields (RF coupling)
- Magnetic fields with power frequency
- Bus system
- Power supply
- Protected earth conductor

Depending on the spreading medium (lead bound or lead free) and the distance to the interference cause, interferences to your control occur by means of different coupling mechanisms.

There are:

- galvanic coupling
- capacitive coupling
- inductive coupling
- radiant coupling

Basic rules for EMC

In the most times it is enough to take care of some elementary rules to guarantee the EMC. Please regard the following basic rules when installing your PLC.

- Take care of a correct area-wide grounding of the inactive metal parts when installing your components.
 - Install a central connection between the ground and the protected earth conductor system.
 - Connect all inactive metal extensive and impedance-low.
 - Please try not to use aluminium parts. Aluminium is easily oxidizing and is therefore less suitable for grounding.
- When cabling, take care of the correct line routing.
 - Organize your cabling in line groups (high voltage, current supply, signal and data lines).
 - Always lay your high voltage lines and signal respectively data lines in separate channels or bundles.
 - Route the signal and data lines as near as possible beside ground areas (e.g. suspension bars, metal rails, tin cabinet).

- Proof the correct fixing of the lead isolation.
 - Data lines must be laid isolated.
 - Analog lines must be laid isolated. When transmitting signals with small amplitudes the one sided laying of the isolation may be favourable.
 - Lay the line isolation extensively on an isolation/protected earth conductor rail directly after the cabinet entry and fix the isolation with cable clamps.
 - Make sure that the isolation/protected earth conductor rail is connected impedance-low with the cabinet.
 - Use metallic or metallised plug cases for isolated data lines.
- In special use cases you should appoint special EMC actions.
 - Consider to wire all inductivities with erase links.
 - Please consider luminescent lamps can influence signal lines.
- Create a homogeneous reference potential and ground all electrical operating supplies when possible.
 - Please take care for the targeted employment of the grounding actions. The grounding of the PLC serves for protection and functionality activity.
 - Connect installation parts and cabinets with your PLC in star topology with the isolation/protected earth conductor system. So you avoid ground loops.
 - If there are potential differences between installation parts and cabinets, lay sufficiently dimensioned potential compensation lines.

Isolation of conductors

Electrical, magnetically and electromagnetic interference fields are weakened by means of an isolation, one talks of absorption. Via the isolation rail, that is connected conductive with the rack, interference currents are shunt via cable isolation to the ground. Here you have to make sure, that the connection to the protected earth conductor is impedance-low, because otherwise the interference currents may appear as interference cause.

When isolating cables you have to regard the following:

- If possible, use only cables with isolation tangle.
- The hiding power of the isolation should be higher than 80%.
- Normally you should always lay the isolation of cables on both sides. Only by means of the both-sided connection of the isolation you achieve high quality interference suppression in the higher frequency area. Only as exception you may also lay the isolation one-sided. Then you only achieve the absorption of the lower frequencies. A one-sided isolation connection may be convenient, if:
 - the conduction of a potential compensating line is not possible.
 - analog signals (some mV respectively μA) are transferred.
 - foil isolations (static isolations) are used.
- With data lines always use metallic or metallised plugs for serial couplings. Fix the isolation of the data line at the plug rack. Do not lay the isolation on the PIN 1 of the plug bar!
- At stationary operation it is convenient to strip the insulated cable interruption free and lay it on the isolation/protected earth conductor line.
- To fix the isolation tangles use cable clamps out of metal. The clamps must clasp the isolation extensively and have well contact.
- Lay the isolation on an isolation rail directly after the entry of the cable in the cabinet. Lead the isolation further on to your PLC and don't lay it on there again!



CAUTION!

Please regard at installation!

At potential differences between the grounding points, there may be a compensation current via the isolation connected at both sides.

Remedy: Potential compensation line

General data

2.8 General data

Conformity and approval

Conformity

CE	2014/35/EU	Low-voltage directive
	2014/30/EU	EMC directive

Approval

UL	-	Refer to Technical data
----	---	-------------------------

others

RoHS	2011/65/EU	Restriction of the use of certain hazardous substances in electrical and electronic equipment
------	------------	---

Protection of persons and device protection

Type of protection	-	IP20
--------------------	---	------

Electrical isolation

to the field bus	-	electrically isolated
------------------	---	-----------------------

to the process level	-	electrically isolated
----------------------	---	-----------------------

Insulation resistance	-	-
-----------------------	---	---

Insulation voltage to reference earth

Inputs / outputs	-	AC / DC 50V, test voltage AC 500V
------------------	---	-----------------------------------

Protective measures	-	against short circuit
---------------------	---	-----------------------

Environmental conditions to EN 61131-2

Climatic

Storage / transport	EN 60068-2-14	-25...+70°C
---------------------	---------------	-------------

Operation

Horizontal installation hanging	EN 61131-2	0...+60°C
---------------------------------	------------	-----------

Horizontal installation lying	EN 61131-2	0...+60°C
-------------------------------	------------	-----------

Vertical installation	EN 61131-2	0...+60°C
-----------------------	------------	-----------

Air humidity	EN 60068-2-30	RH1 (without condensation, rel. humidity 10...95%)
--------------	---------------	--

Pollution	EN 61131-2	Degree of pollution 2
-----------	------------	-----------------------

Installation altitude max.	-	2000m
----------------------------	---	-------

Mechanical

Oscillation	EN 60068-2-6	1g, 9Hz ... 150Hz
-------------	--------------	-------------------

Shock	EN 60068-2-27	15g, 11ms
-------	---------------	-----------

Mounting conditions

Mounting place	-	In the control cabinet
Mounting position	-	Horizontal and vertical

EMC	Standard	Comment
Emitted interference	EN 61000-6-4	Class A (Industrial area)
Noise immunity zone B	EN 61000-6-2	Industrial area
	EN 61000-4-2	ESD 8kV at air discharge (degree of severity 3), 4kV at contact discharge (degree of severity 2)
	EN 61000-4-3	HF field immunity (casing) 80MHz ... 1000MHz, 10V/m, 80% AM (1kHz) 1.4GHz ... 2.0GHz, 3V/m, 80% AM (1kHz) 2GHz ... 2.7GHz, 1V/m, 80% AM (1kHz)
	EN 61000-4-6	HF conducted 150kHz ... 80MHz, 10V, 80% AM (1kHz)
	EN 61000-4-4	Burst, degree of severity 3
	EN 61000-4-5	Surge, degree of severity 3 *

*) Due to the high-energetic single pulses with Surge an appropriate external protective circuit with lightning protection elements like conductors for lightning and overvoltage is necessary.

3 Digital in-/output

3.1 M21-1BH00 - DI 16xDC 24V

Properties

The module detects the binary control signals from the process level and transmits them isolated to the higher-level bus system. It has 16 channels and their status is indicated by LEDs.

- 16 digital Inputs isolated to the backplane bus
- Suitable for switches and proximity switches
- Status indication of the channels via LEDs

Structure

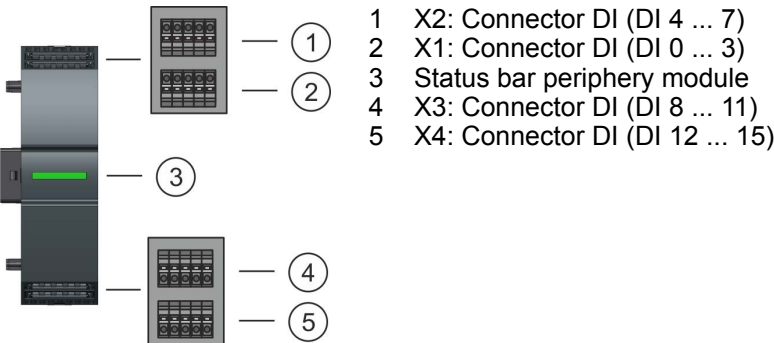

Status bar

LED	Description
	LEDs green on: Backplane bus communication and module status are OK
	LED red on: Module reports an error
	LED red blinks with 1Hz: Error in configuration
	LEDs green are blinking with 1Hz: Error backplane bus communication

LEDs connectors

Digital input	LED	Description
DI +0.0 DI +0.7		Digital I+0.0 ... 0.7 has "1" signal
		Digital I+0.0 ... 0.7 has "0" signal
DI +1.0 ... DI +1.7		Digital input I+1.0 ... 1.7 has "1" signal
		Digital input I+1.0 ... 1.7 has "0" signal

Pin assignment

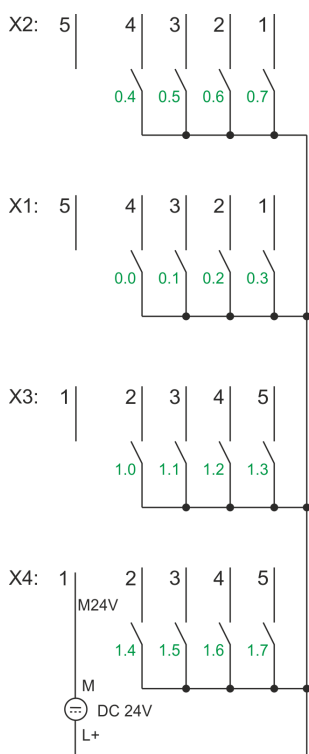

X	Pin	Function	Type	LED	Description
X2:	1	+0.7	I	green	Digital input DI 7
	2	+0.6	I	green	Digital input DI 6
	3	+0.5	I	green	Digital input DI 5
	4	+0.4	I	green	Digital input DI 4
	5	-	-		reserved
X1:	1	+0.3	I	green	Digital input DI 3
	2	+0.2	I	green	Digital input DI 2
	3	+0.1	I	green	Digital input DI 1
	4	+0.0	I	green	Digital input DI 0
	5	-	-		reserved
X3:	1	-	-		reserved
	2	+1.0	I	green	Digital input DI 8
	3	+1.1	I	green	Digital input DI 9
	4	+1.2	I	green	Digital input DI 10
	5	+1.3	I	green	Digital input DI 11
X4:	1	0V	I		Ground DI
	2	+1.4	I	green	Digital input DI 12
	3	+1.5	I	green	Digital input DI 13
	4	+1.6	I	green	Digital input DI 14
	5	+1.7	I	green	Digital input DI 15

I: Input

Input area

At the CPU the input area is embedded to the corresponding address area.

M21-1BH00 - DI 16xDC 24V

Addr.	Name	Byte	Function
+0	PII	0	Status of the inputs <ul style="list-style-type: none"> ■ Bit 0: DI 0 ■ Bit 1: DI 1 ■ Bit 2: DI 2 ■ Bit 3: DI 3 ■ Bit 4: DI 4 ■ Bit 5: DI 5 ■ Bit 6: DI 6 ■ Bit 7: DI 7
		1	Status of the inputs <ul style="list-style-type: none"> ■ Bit 0: DI 8 ■ Bit 1: DI 9 ■ Bit 2: DI 10 ■ Bit 3: DI 11 ■ Bit 4: DI 12 ■ Bit 5: DI 13 ■ Bit 6: DI 14 ■ Bit 7: DI 15

Output area

No byte of the output area is used by the module.

3.1.1 Technical data

Order no.	M21-1BH00
Type	SM M21
Module ID	0014 9FC2
Current consumption/power loss	
Current consumption from backplane bus	65 mA
Power loss	0.9 W
Technical data digital inputs	
Number of inputs	16
Cable length, shielded	1000 m
Cable length, unshielded	600 m
Rated load voltage	-
Current consumption from load voltage L+ (without load)	25 mA
Rated value	DC 20.4...28.8 V
Input voltage for signal "0"	DC 0...5 V
Input voltage for signal "1"	DC 15...28.8 V
Input voltage hysteresis	-
Frequency range	-
Input resistance	-
Input current for signal "1"	3 mA
Connection of Two-Wire-BEROs possible	✓
Max. permissible BERO quiescent current	0.5 mA
Input delay of "0" to "1"	3 ms
Input delay of "1" to "0"	3 ms
Number of simultaneously utilizable inputs horizontal configuration	16
Number of simultaneously utilizable inputs vertical configuration	16
Input characteristic curve	IEC 61131-2, type 1
Initial data size	16 Bit
Status information, alarms, diagnostics	
Status display	green LED per channel
Interrupts	no
Process alarm	no
Diagnostic interrupt	no
Diagnostic functions	no
Diagnostics information read-out	none
Module state	none

Order no.	M21-1BH00
Module error display	red LED
Channel error display	none
Isolation	
Between channels	-
Between channels of groups to	-
Between channels and backplane bus	✓
Insulation tested with	DC 500 V
Datasizes	
Input bytes	2
Output bytes	0
Parameter bytes	0
Diagnostic bytes	0
Housing	
Material	PPE / PPE GF10
Mounting	Profile rail 35 mm
Mechanical data	
Dimensions (WxHxD)	26 mm x 88 mm x 71 mm
Net weight	91 g
Weight including accessories	91 g
Gross weight	104 g
Environmental conditions	
Operating temperature	0 °C to 60 °C
Storage temperature	-25 °C to 70 °C
Certifications	
UL certification	in preparation
KC certification	in preparation

3.2 M22-1BH00 - DO 16xDC 24V 0.5A

Properties

The module detects the binary control signals from the higher-level bus system and transports them to the process level via the outputs. It has 16 channels and their status is indicated by LEDs.

- 16 digital outputs isolated to the backplane bus
- Status indication of the channels via LEDs
- Diagnostic function can be parametrized in case of overload

Structure

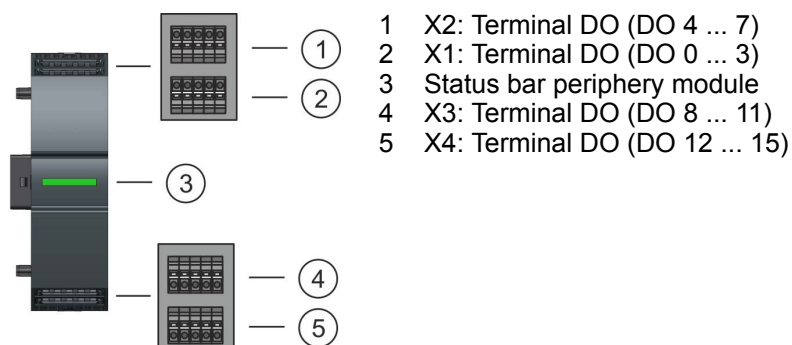

Status bar

LED	Description
	LEDs green on: Backplane bus communication and module status are OK
	LED red on: Module reports an error, e.g. on overload at an output
	LED red blinks with 1Hz: Error in configuration
	LEDs green are blinking with 1Hz: Error backplane bus communication

LEDs connectors

Digital output	LED	Description
DO +0.0 ... DO +0.7		Digital output Q+0.0 ... 0.7 has "1" signal
		Digital output Q+0.0 ... 0.7 has "0" signal
DO +1.0 ... DO +1.7		Digital output Q+1.0 ... 1.7 has "1" signal
		Digital output Q+1.0 ... 1.7 has "0" signal

M22-1BH00 - DO 16xDC 24V 0.5A

Pin assignment

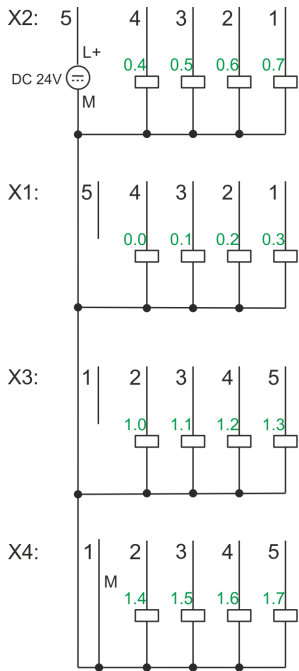

X	Pin	Function	Type	LED	Description
X2:	1	+0.7	O	green	Digital output DO 7
	2	+0.6	O	green	Digital output DO 6
	3	+0.5	O	green	Digital output DO 5
	4	+0.4	O	green	Digital output DO 4
	5	DC 24V	I		Power supply DC 24V (L+)
X1:	1	+0.3	O	green	Digital output DO 3
	2	+0.2	O	green	Digital output DO 2
	3	+0.1	O	green	Digital output DO 1
	4	+0.0	O	green	Digital output DO 0
	5	-	-		reserved
X3:	1	-	-		reserved
	2	+1.0	O	green	Digital output DO 8
	3	+1.1	O	green	Digital output DO 9
	4	+1.2	O	green	Digital output DO 10
	5	+1.3	O	green	Digital output DO 11
X4:	1	0V	O		Power supply ground
	2	+1.4	O	green	Digital output DO 12
	3	+1.5	O	green	Digital output DO 13
	4	+1.6	O	green	Digital output DO 14
	5	+1.7	O	green	Digital output DO 15

I: Input, O: Output



CAUTION!

Feeding in voltage at an output is not allowed and can destroy the module!

Input area

No byte of the input area is used by the module.

Output area

Addr.	Name	Byte	Function
+0	PIQ	0	Status of the outputs <ul style="list-style-type: none"> ■ Bit 0: DO 0 ■ Bit 1: DO 1 ■ Bit 2: DO 2 ■ Bit 3: DO 3 ■ Bit 4: DO 4 ■ Bit 5: DO 5 ■ Bit 6: DO 6 ■ Bit 7: DO 7
		1	Status of the outputs <ul style="list-style-type: none"> ■ Bit 0: DO 8 ■ Bit 1: DO 9 ■ Bit 2: DO 10 ■ Bit 3: DO 11 ■ Bit 4: DO 12 ■ Bit 5: DO 13 ■ Bit 6: DO 14 ■ Bit 7: DO 15

Parameter data

The module has the following parameter data, which can be set in the hardware configuration:

- Diagnostic interrupt
 - When enabled, a diagnostic interrupt is triggered when an output is overloaded.



Regardless of the parametrization, the red LED  of the status bar lights up on overload. The LED lights up as long as there is an overload.

3.2.1 Diagnostic data

Via the parametrization you may activate a diagnostic interrupt for the module. With a diagnostic interrupt the module serves for diagnostic data for diagnostic_{incoming}. As soon as the reason for releasing a diagnostic interrupt is no longer present, the diagnostic interrupt_{going} automatically takes place. Via record set 01h the diagnostic data can be accessed.

Name	Bytes	Function	Default
ERR_A	1	Diagnostic	00h
MODTYP	1	Module information	0Fh
ERR_C	1	reserved	00h
ERR_D	1	reserved	00h
CHTYP	1	Channel type	72h

M22-1BH00 - DO 16xDC 24V 0.5A > Diagnostic data

Name	Bytes	Function	Default
NUMBIT	1	Number diagnostic bits per channel	00h
NUMCH	1	Number channels of the module	00h
CHERR	1	reserved	00h
CH0ERR...CH7ERR	8	reserved	00h
DIAG_US	4	µs ticker (32bit)	00h

ERR_A Diagnostic

Byte	Bit 7 ... 0
0	<ul style="list-style-type: none"> ■ Bit 0: set at module failure ■ Bit 1: set at internal error ■ Bit 2: set at external error ■ Bit 3: reserved ■ Bit 4: set at overload at an output ■ Bit 6 ... 5: reserved ■ Bit 7: set at error in parametrization

MODTYP Module information

Byte	Bit 7 ... 0
0	<ul style="list-style-type: none"> ■ Bit 3 ... 0: module class <ul style="list-style-type: none"> – 1111b: digital module ■ Bit 7 ... 4: reserved

CHTYP Channel type

Byte	Bit 7 ... 0
0	<ul style="list-style-type: none"> ■ Bit 6 ... 0: Channel type <ul style="list-style-type: none"> – 72h: Digital output ■ Bit 7: reserved

NUMBIT Diagnostic bits

Byte	Bit 7 ... 0
0	Number of diagnostic bits per channel (here 00h)

NUMCH Channels

Byte	Bit 7 ... 0
0	Number of channels of the module (here 00h)

DIAG_US µs ticker

Byte	Bit 7 ... 0
0...3	Value of the µs ticker at the moment of the diagnostic <ul style="list-style-type: none"> ■ In the System MICRO module there is a timer (µs ticker). With PowerON the timer starts counting with 0. After $2^{32}-1\mu\text{s}$ the timer starts with 0 again.

3.2.2 Technical data

Order no.	M22-1BH00
Type	SM M22
Module ID	0114 2F50
Current consumption/power loss	
Current consumption from backplane bus	80 mA
Power loss	0.7 W
Technical data digital outputs	
Number of outputs	16
Cable length, shielded	1000 m
Cable length, unshielded	600 m
Rated load voltage	DC 20.4...28.8 V
Current consumption from load voltage L+ (without load)	20 mA
Total current per group, horizontal configuration, 40°C	8 A
Total current per group, horizontal configuration, 60°C	8 A
Total current per group, vertical configuration	8 A
Output current at signal "1", rated value	0.5 A
Output delay of "0" to "1"	30 µs
Output delay of "1" to "0"	175 µs
Minimum load current	-
Lamp load	10 W
Parallel switching of outputs for redundant control of a load	not possible
Parallel switching of outputs for increased power	not possible
Actuation of digital input	✓
Switching frequency with resistive load	max. 1000 Hz
Switching frequency with inductive load	max. 0.5 Hz
Switching frequency on lamp load	max. 10 Hz
Internal limitation of inductive shut-off voltage	L+ (-45 V)
Short-circuit protection of output	yes, electronic
Trigger level	1 A
Number of operating cycle of relay outputs	-
Switching capacity of contacts	-
Output data size	16 Bit
Status information, alarms, diagnostics	
Status display	green LED per channel
Interrupts	yes, parameterizable
Process alarm	no

M22-1BH00 - DO 16xDC 24V 0.5A > Technical data

Order no.	M22-1BH00
Diagnostic interrupt	yes, parameterizable
Diagnostic functions	yes, parameterizable
Diagnostics information read-out	possible
Supply voltage display	green LED
Group error display	red LED
Channel error display	none
Isolation	
Between channels	-
Between channels of groups to	-
Between channels and backplane bus	✓
Insulation tested with	DC 500 V
Datasizes	
Input bytes	0
Output bytes	2
Parameter bytes	0
Diagnostic bytes	20
Housing	
Material	PPE / PPE GF10
Mounting	Profile rail 35 mm
Mechanical data	
Dimensions (WxHxD)	26 mm x 88 mm x 71 mm
Net weight	96 g
Weight including accessories	96 g
Gross weight	109 g
Environmental conditions	
Operating temperature	0 °C to 60 °C
Storage temperature	-25 °C to 70 °C
Certifications	
UL certification	in preparation
KC certification	in preparation

3.3 M22-1HF10 - DO 8xRelay

Properties

The module detects the binary control signals from the higher-level bus system and transports them to the process level via the relay outputs. It has 8 channels and the status of each channel is monitored via LEDs.

- 8 digital outputs isolated to the backplane bus
 - in groups of two, each with a common terminal
 - isolated between channels and backplane bus
 - isolated between channels of groups
- DC30V / AC230V, 2A
- Status indication of the channels via LEDs

Structure

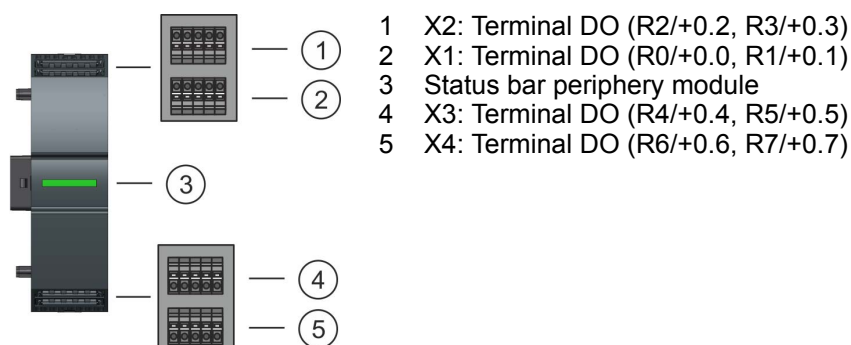

- 1 X2: Terminal DO (R2/+0.2, R3/+0.3)
- 2 X1: Terminal DO (R0/+0.0, R1/+0.1)
- 3 Status bar periphery module
- 4 X3: Terminal DO (R4/+0.4, R5/+0.5)
- 5 X4: Terminal DO (R6/+0.6, R7/+0.7)

Status bar

LED	Description
	LEDs green on: Backplane bus communication and module status are OK
	LED red on: Module reports an error with overload, short circuit or overheat
	LED red blinks with 1Hz: Error in configuration
	LEDs green are blinking with 1Hz: Error backplane bus communication

LEDs connectors

Relay output	LED	Description
DO +0.0 ... DO +0.7	green	Relay output Q+0.0 ... 0.7 has "1" signal
		Relay output Q+0.0 ... 0.7 has "0" signal

M22-1HF10 - DO 8xRelay

Pin assignment

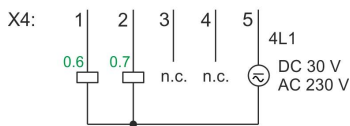
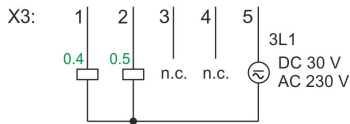
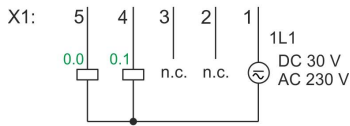
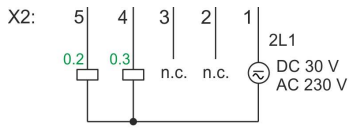

	Pin	Function	Type	LED	Description
X2:	1	2L1	O	-	Relay output DO 2 and DO 3
	2	-	-	-	must not be connected
	3	-	-	-	must not be connected
	4	+0.3	O	■ green	Relay output DO 3
	5	+0.2	O	■ green	Relay output DO 2
X1:	1	1L1	O	-	Relay output DO 0 und DO 1
	2	-	-	-	must not be connected
	3	-	-	-	must not be connected
	4	+0.1	O	■ green	Relay output DO 1
	5	+0.0	O	■ green	Relay output DO 0
X3:	1	+0.4	O	■ green	Relay output DO 4
	2	+0.5	O	■ green	Relay output DO 5
	3	-	-	-	must not be connected
	4	-	-	-	must not be connected
	5	3L1	O	-	Relay output DO 4 and DO 5
X4:	1	+0.6	O	■ green	Relay output DO 6
	2	+0.7	O	■ green	Relay output DO 7
	3	-	-	-	must not be connected
	4	-	-	-	must not be connected
	5	4L1	O	-	Relay output DO 6 and DO 7

O: Output



CAUTION!

- Due to the hardware the free pins must not be connected!
- The mixed operation of touch and non touch voltages is not permitted!



When using inductive load please take a suitable protector (see installation guidelines).

Maximum load / Service life (typical)

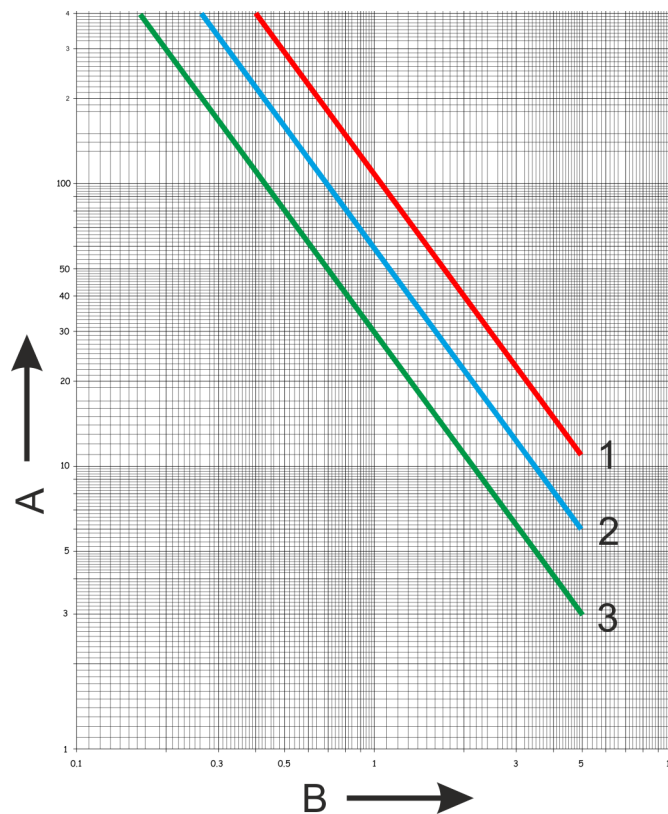

- A Operating cycles (x 10⁴)
- B Current in A
- 1 DC 30V resistive load
- 2 AC 250V resistive load, DC 30V L/R = 7ms
- 3 AC 250V cosφ = 0.4

Input area

No byte of the input area is used by the module.

Output area

Addr.	Name	Byte	Function
+0	PIQ	0	Status of the outputs <ul style="list-style-type: none"> ■ Bit 0: Relay output DO 0 ■ Bit 1: Relay output DO 1 ■ Bit 2: Relay output DO 2 ■ Bit 3: Relay output DO 3 ■ Bit 4: Relay output DO 4 ■ Bit 5: Relay output DO 5 ■ Bit 6: Relay output DO 6 ■ Bit 7: Relay output DO 7

3.3.1 Technical data

Order no.	M22-1HF10
Type	SM M 22 - Digital Output
Module ID	0115 AFC8
Current consumption/power loss	
Current consumption from backplane bus	140 mA
Power loss	1.5 W
Technical data digital outputs	
Number of outputs	8
Cable length, shielded	1000 m
Cable length, unshielded	600 m
Rated load voltage	DC 30 V/ AC 230 V
Current consumption from load voltage L+ (without load)	-
Total current per group, horizontal configuration, 40°C	4 A
Total current per group, horizontal configuration, 60°C	-
Total current per group, vertical configuration	-
Output current at signal "1", rated value	2 A
Output delay of "0" to "1"	10 ms
Output delay of "1" to "0"	5 ms
Minimum load current	-
Lamp load	-
Parallel switching of outputs for redundant control of a load	not possible
Parallel switching of outputs for increased power	not possible
Actuation of digital input	-
Switching frequency with resistive load	max. 0.33 Hz
Switching frequency with inductive load	max. 0.33 Hz
Switching frequency on lamp load	max. 0.33 Hz
Internal limitation of inductive shut-off voltage	-
Short-circuit protection of output	-
Trigger level	-
Number of operating cycle of relay outputs	-
Switching capacity of contacts	5 A
Output data size	8 Bit
Status information, alarms, diagnostics	
Status display	green LED per channel
Interrupts	no
Process alarm	no

Order no.	M22-1HF10
Diagnostic interrupt	no
Diagnostic functions	no
Diagnostics information read-out	none
Supply voltage display	green LED
Group error display	red LED
Channel error display	none
Isolation	
Between channels	-
Between channels of groups to	2
Between channels and backplane bus	✓
Insulation tested with	AC 2200 V
Datasizes	
Input bytes	0
Output bytes	1
Parameter bytes	0
Diagnostic bytes	0
Housing	
Material	PPE / PPE GF10
Mounting	Profile rail 35 mm
Mechanical data	
Dimensions (WxHxD)	26 mm x 88 mm x 71 mm
Net weight	110 g
Weight including accessories	110 g
Gross weight	123 g
Environmental conditions	
Operating temperature	0 °C to 60 °C
Storage temperature	-25 °C to 70 °C
Certifications	
UL certification	in preparation
KC certification	in preparation

3.4 M23-1BH00 - DI8/DO8 0.5A

Properties

The module is a mixed module. It has 8 input channels and 8 output channels. The status of the channels is indicated by LEDs.

- 8 digital inputs and 8 digital outputs electrically isolated from the backplane bus
- Status indication of the channels via LEDs
- Diagnostic function can be parametrized in case of overload

Structure

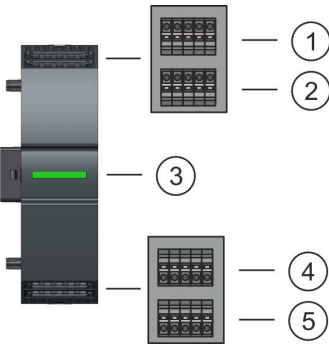

- 1 X2: Terminal DO (DO 4 ... 7)
- 2 X1: Terminal DO (DO 0 ... 3)
- 3 Status bar periphery module
- 4 X3: Terminal DI (DI 0 ... 3)
- 5 X4: Terminal DI (DI 4 ... 7)

Status bar

LED	Description
	LEDs green on: Backplane bus communication and module status are OK
	LED red on: Module reports an error, e.g. on overload at an output
	LED red blinks with 1Hz: Error in configuration
	LEDs green are blinking with 1Hz: Error backplane bus communication

LEDs connectors

Digital output	LED	Description
DO +0.0 ... DO +0.7	green	Digital output Q+0.0 ... 0.7 has "1" signal
		Digital output Q+0.0 ... 0.7 has "0" signal
Digital input	LED	Description
DI +1.0 ... DI +1.7	green	Digital input I+1.0 ... 1.7 has "1" signal
		Digital input I+1.0 ... 1.7 has "0" signal

Pin assignment

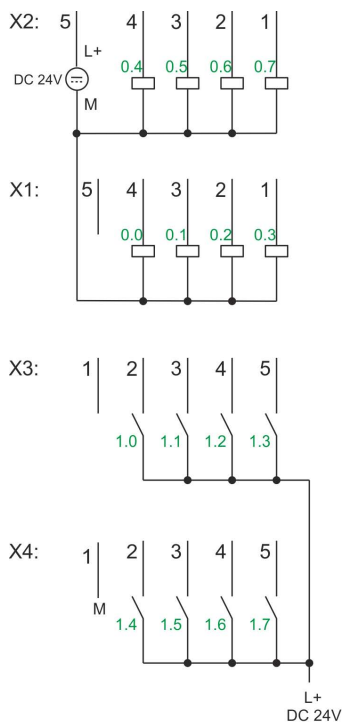

X	Pin	Function	Type	LED	Description
X2:	1	+0.7	O	green	Digital output DO 7
	2	+0.6	O	green	Digital output DO 6
	3	+0.5	O	green	Digital output DO 5
	4	+0.4	O	green	Digital output DO 4
	5	DC24V	I		Load voltage DC 24V for DO (L+)
X1:	1	+0.3	O	green	Digital output DO 3
	2	+0.2	O	green	Digital output DO 2
	3	+0.1	O	green	Digital output DO 1
	4	+0.0	O	green	Digital output DO 0
	5	-	-		reserved
X3:	1	-	-		reserved
	2	+1.0	I	green	Digital input DI 4
	3	+1.1	I	green	Digital input DI 5
	4	+1.2	I	green	Digital input DI 6
	5	+1.3	I	green	Digital input DI 7
X4:	1	0V	I		Ground DI
	2	+1.4	I	green	Digital input DI 0
	3	+1.5	I	green	Digital input DI 1
	4	+1.6	I	green	Digital input DI 2
	5	+1.7	I	green	Digital input DI 3

Input area

Addr.	Name	Byte	Function
+0	PII	0	Status of the inputs ■ Bit 0: DI 0 ■ Bit 1: DI 1 ■ Bit 2: DI 2 ■ Bit 3: DI 3 ■ Bit 4: DI 4 ■ Bit 5: DI 5 ■ Bit 6: DI 6 ■ Bit 7: DI 7

Output area

Addr.	Name	Byte	Function
+0	PIQ	0	Status of the outputs <ul style="list-style-type: none"> ■ Bit 0: DO 0 ■ Bit 1: DO 1 ■ Bit 2: DO 2 ■ Bit 3: DO 3 ■ Bit 4: DO 4 ■ Bit 5: DO 5 ■ Bit 6: DO 6 ■ Bit 7: DO 7

Parameter data

The module has the following parameter data, which can be set in the hardware configuration:

- Diagnostic interrupt
 - When enabled, a diagnostic interrupt is triggered when an output is overloaded.



Regardless of the parametrization, the red LED  of the status bar lights up on overload. The LED lights up as long as there is an overload.

3.4.1 Diagnostic data

Via the parametrization you may activate a diagnostic interrupt for the module. With a diagnostic interrupt the module serves for diagnostic data for `diagnostic_incoming`. As soon as the reason for releasing a diagnostic interrupt is no longer present, the diagnostic interrupt `going` automatically takes place. Via record set 01h the diagnostic data can be accessed.

Name	Bytes	Function	Default
ERR_A	1	Diagnostic	00h
MODTYP	1	Module information	0Fh
ERR_C	1	reserved	00h
ERR_D	1	reserved	00h
CHTYP	1	Channel type	72h
NUMBIT	1	Number diagnostic bits per channel	00h
NUMCH	1	Number channels of the module	00h
CHERR	1	reserved	00h
CH0ERR...CH7ERR	8	reserved	00h
DIAG_US	4	µs ticker (32bit)	00h

ERR_A Diagnostic

Byte	Bit 7 ... 0
0	<ul style="list-style-type: none"> ■ Bit 0: set at module failure ■ Bit 1: set at internal error ■ Bit 2: set at external error ■ Bit 3: reserved ■ Bit 4: set at overload at an output ■ Bit 6 ... 5: reserved ■ Bit 7: set at error in parametrization

MODTYP Module information

Byte	Bit 7 ... 0
0	<ul style="list-style-type: none"> ■ Bit 3 ... 0: module class <ul style="list-style-type: none"> – 1111b: digital module ■ Bit 7 ... 4: reserved

CHTYP Channel type

Byte	Bit 7 ... 0
0	<ul style="list-style-type: none"> ■ Bit 6 ... 0: Channel type <ul style="list-style-type: none"> – 72h: Digital output ■ Bit 7: reserved

NUMBIT Diagnostic bits

Byte	Bit 7 ... 0
0	Number of diagnostic bits per channel (here 00h)

NUMCH Channels

Byte	Bit 7 ... 0
0	Number of channels of the module (here 00h)

DIAG_US μ s ticker

Byte	Bit 7 ... 0
0...3	Value of the μ s ticker at the moment of the diagnostic <ul style="list-style-type: none"> ■ In the System MICRO module there is a timer (μs ticker). With PowerON the timer starts counting with 0. After $2^{32}-1\mu$s the timer starts with 0 again.

3.4.2 Technical data

Order no.	M23-1BH00
Type	SM M23
Module ID	0015 3F49
Current consumption/power loss	
Current consumption from backplane bus	80 mA
Power loss	0.7 W
Technical data digital inputs	
Number of inputs	8
Cable length, shielded	1000 m
Cable length, unshielded	600 m
Rated load voltage	DC 24 V
Current consumption from load voltage L+ (without load)	25 mA
Rated value	DC 20.4...28.8 V
Input voltage for signal "0"	DC 0...5 V
Input voltage for signal "1"	DC 15...28.8 V
Input voltage hysteresis	-
Frequency range	-
Input resistance	-
Input current for signal "1"	3 mA
Connection of Two-Wire-BEROs possible	✓
Max. permissible BERO quiescent current	0.5 mA
Input delay of "0" to "1"	3 ms
Input delay of "1" to "0"	3 ms
Number of simultaneously utilizable inputs horizontal configuration	8
Number of simultaneously utilizable inputs vertical configuration	8
Input characteristic curve	IEC 61131-2, type 1
Initial data size	8 Bit
Technical data digital outputs	
Number of outputs	8
Cable length, shielded	1000 m
Cable length, unshielded	600 m
Rated load voltage	DC 20.4...28.8 V
Reverse polarity protection of rated load voltage	-
Current consumption from load voltage L+ (without load)	20 mA
Total current per group, horizontal configuration, 40°C	4 A

Order no.	M23-1BH00
Total current per group, horizontal configuration, 60°C	4 A
Total current per group, vertical configuration	4 A
Output current at signal "1", rated value	0.5 A
Output delay of "0" to "1"	30 µs
Output delay of "1" to "0"	175 µs
Minimum load current	-
Lamp load	10 W
Parallel switching of outputs for redundant control of a load	not possible
Parallel switching of outputs for increased power	not possible
Actuation of digital input	✓
Switching frequency with resistive load	max. 1000 Hz
Switching frequency with inductive load	max. 0.5 Hz
Switching frequency on lamp load	max. 10 Hz
Internal limitation of inductive shut-off voltage	L+ (-45 V)
Short-circuit protection of output	yes, electronic
Trigger level	1 A
Number of operating cycle of relay outputs	-
Switching capacity of contacts	-
Output data size	8 Bit
Status information, alarms, diagnostics	
Status display	green LED per channel
Interrupts	yes, parameterizable
Process alarm	no
Diagnostic interrupt	yes, parameterizable
Diagnostic functions	yes, parameterizable
Diagnostics information read-out	possible
Module state	green LED
Module error display	red LED
Channel error display	none
Isolation	
Between channels	-
Between channels of groups to	-
Between channels and backplane bus	✓
Insulation tested with	DC 500 V
Datasizes	
Input bytes	1

M23-1BH00 - DI8/DO8 0.5A > Technical data

Order no.	M23-1BH00
Output bytes	1
Parameter bytes	0
Diagnostic bytes	20
Housing	
Material	PPE / PPE GF10
Mounting	Profile rail 35 mm
Mechanical data	
Dimensions (WxHxD)	26 mm x 88 mm x 71 mm
Net weight	92 g
Weight including accessories	92 g
Gross weight	105 g
Environmental conditions	
Operating temperature	0 °C to 60 °C
Storage temperature	-25 °C to 70 °C
Certifications	
UL certification	in preparation
KC certification	in preparation