

# VIPA System 200V

**PS-CM | Manual**

HB97E\_PS-CM | Rev. 14/47

November 2014

## **Copyright © VIPA GmbH. All Rights Reserved.**

This document contains proprietary information of VIPA and is not to be disclosed or used except in accordance with applicable agreements.

This material is protected by the copyright laws. It may not be reproduced, distributed, or altered in any fashion by any entity (either internal or external to VIPA), except in accordance with applicable agreements, contracts or licensing, without the express written consent of VIPA and the business management owner of the material.

For permission to reproduce or distribute, please contact:  
VIPA, Gesellschaft für Visualisierung und Prozessautomatisierung mbH  
Ohmstraße 4, D-91074 Herzogenaurach, Germany  
Tel.: +49 (91 32) 744 -0  
Fax.: +49 9132 744 1864  
EMail: info@vipa.de  
<http://www.vipa.com>

## **Note**

Every effort has been made to ensure that the information contained in this document was complete and accurate at the time of publishing. Nevertheless, the authors retain the right to modify the information. This customer document describes all the hardware units and functions known at the present time. Descriptions may be included for units which are not present at the customer site. The exact scope of delivery is described in the respective purchase contract.

## **CE Conformity Declaration**

Hereby, VIPA GmbH declares that the products and systems are in compliance with the essential requirements and other relevant provisions.

Conformity is indicated by the CE marking affixed to the product.

## **Conformity Information**

For more information regarding CE marking and Declaration of Conformity (DoC), please contact your local VIPA customer service organization.

## **Trademarks**

VIPA, SLIO, System 100V, System 200V, System 300V, System 300S, System 400V, System 500S and Commander Compact are registered trademarks of VIPA Gesellschaft für Visualisierung und Prozessautomatisierung mbH.

SPEED7 is a registered trademark of profichip GmbH.

SIMATIC, STEP, SINEC, TIA Portal, S7-300 and S7-400 are registered trademarks of Siemens AG.

Microsoft und Windows are registered trademarks of Microsoft Inc., USA.

Portable Document Format (PDF) and Postscript are registered trademarks of Adobe Systems, Inc.

All other trademarks, logos and service or product marks specified herein are owned by their respective companies.

## **Information product support**

Contact your local VIPA Customer Service Organization representative if you wish to report errors or questions regarding the contents of this document. If you are unable to locate a customer service center, contact VIPA as follows:

VIPA GmbH, Ohmstraße 4, 91074 Herzogenaurach, Germany

Telefax: +49 9132 744 1204  
EMail: [documentation@vipa.de](mailto:documentation@vipa.de)

## **Technical support**

Contact your local VIPA Customer Service Organization representative if you encounter problems with the product or have questions regarding the product. If you are unable to locate a customer service center, contact VIPA as follows:

VIPA GmbH, Ohmstraße 4, 91074 Herzogenaurach, Germany

Telephone: +49 9132 744 1150 (Hotline)  
EMail: [support@vipa.de](mailto:support@vipa.de)

# Contents

<b>About this manual .....</b>	<b>1</b>
<b>Safety information .....</b>	<b>2</b>
<b>Chapter 1 Basics and Assembly .....</b>	<b>1-1</b>
Safety Information for Users.....	1-2
System conception .....	1-3
Dimensions .....	1-5
Installation .....	1-7
Demounting and module exchange .....	1-11
Wiring.....	1-12
Installation guidelines .....	1-14
General data .....	1-17
<b>Chapter 2 Power supplies - PS.....</b>	<b>2-1</b>
Safety precautions .....	2-2
System overview .....	2-3
PS 207/2 - Power supply - Structure .....	2-4
PS 207/2CM - Power supply with Clamps - Structure.....	2-6
Installation .....	2-8
Cabling.....	2-9
Technical data.....	2-10
<b>Chapter 3 System expansion modules - CM .....</b>	<b>3-1</b>
System overview .....	3-2
CM 240 - 4port mini switch .....	3-3
CM 201 - Terminal modules .....	3-6



## About this manual

This manual describes the System 200V PS/CM modules that are available from VIPA. In addition to the product summary it contains detailed descriptions of the different modules. You are provided with information on the connection and the utilization of the System 200V PS/CM modules. Every chapter is concluded with the technical data of the respective module.

### Overview

#### **Chapter 1: Assembly and installation guidelines**

The focus of this chapter is on the introduction of the VIPA System 200V. Here you will find the information required to assemble and wire a controller system consisting of System 200V components.

Besides the dimensions the general technical data of System 200V will be found.

#### **Chapter 2: Power supplies - PS**

This chapter deals with external power supplies for the System 200V. Here you find a comprehensive set of safety related hints and information as well as details on the construction, the installation and commissioning of the module.

#### **Chapter 3: System expansion modules - CM**

This chapter deals with the system expansion modules that are available for the System 200V. These include the mini switch CM 240 and terminal modules required for the expansion of the available number of connections.

<b>Objective and contents</b>	This manual describes the digital signal modules (SM) of the System 200V. It contains a description of the construction, project implementation and the technical data.
<b>Target audience</b>	The manual is targeted at users who have a background in automation technology.
<b>Structure of the manual</b>	The manual consists of chapters. Every chapter provides a self-contained description of a specific topic.
<b>Guide to the document</b>	The following guides are available in the manual: <ul style="list-style-type: none"><li>• an overall table of contents at the beginning of the manual</li><li>• an overview of the topics for every chapter</li></ul>
<b>Availability</b>	The manual is available in: <ul style="list-style-type: none"><li>• printed form, on paper</li><li>• in electronic form as PDF-file (Adobe Acrobat Reader)</li></ul>

**Icons  
Headings**

Important passages in the text are highlighted by following icons and headings:

**Danger!**

Immediate or likely danger.  
Personal injury is possible.

**Attention!**

Damages to property is likely if these warnings are not heeded.

**Note!**

Supplementary information and useful tips.

## Safety information

### Applications conforming with specifications

The System 200V is constructed and produced for:

- all VIPA System 200V components
- communication and process control
- general control and automation applications
- industrial applications
- operation within the environmental conditions specified in the technical data
- installation into a cubicle



### Danger!

This device is not certified for applications in

- in explosive environments (EX-zone)

### Documentation

The manual must be available to all personnel in the

- project design department
- installation department
- commissioning
- operation



### The following conditions must be met before using or commissioning the components described in this manual:

- Modification to the process control system should only be carried out when the system has been disconnected from power!
- Installation and modifications only by properly trained personnel
- The national rules and regulations of the respective country must be satisfied (installation, safety, EMC ...)

### Disposal

**National rules and regulations apply to the disposal of the unit!**





## Chapter 1 Basics and Assembly

### Overview

The focus of this chapter is on the introduction of the VIPA System 200V. Here you will find the information required to assemble and wire a controller system consisting of System 200V components.

Besides the dimensions the general technical data of System 200V will be found.

### Contents

Topic	Page
<b>Chapter 1 Basics and Assembly</b> .....	<b>1-1</b>
Safety Information for Users .....	1-2
System conception .....	1-3
Dimensions .....	1-5
Installation .....	1-7
Demounting and module exchange .....	1-11
Wiring .....	1-12
Installation guidelines .....	1-14
General data .....	1-17

## Safety Information for Users

### Handling of electrostatic sensitive modules

VIPA modules make use of highly integrated components in MOS-Technology. These components are extremely sensitive to over-voltages that can occur during electrostatic discharges.

The following symbol is attached to modules that can be destroyed by electrostatic discharges.



The Symbol is located on the module, the module rack or on packing material and it indicates the presence of electrostatic sensitive equipment.

It is possible that electrostatic sensitive equipment is destroyed by energies and voltages that are far less than the human threshold of perception. These voltages can occur where persons do not discharge themselves before handling electrostatic sensitive modules and they can damage components thereby, causing the module to become inoperable or unusable.

Modules that have been damaged by electrostatic discharges can fail after a temperature change, mechanical shock or changes in the electrical load.

Only the consequent implementation of protection devices and meticulous attention to the applicable rules and regulations for handling the respective equipment can prevent failures of electrostatic sensitive modules.

### Shipping of electrostatic sensitive modules

Modules must be shipped in the original packing material.

### Measurements and alterations on electrostatic sensitive modules

When you are conducting measurements on electrostatic sensitive modules you should take the following precautions:

- Floating instruments must be discharged before use.
- Instruments must be grounded.

Modifying electrostatic sensitive modules you should only use soldering irons with grounded tips.



### Attention!

Personnel and instruments should be grounded when working on electrostatic sensitive modules.

# System conception

## Overview

The System 200V is a modular automation system for assembly on a 35mm profile rail. By means of the peripheral modules with 4, 8 and 16 channels this system may properly be adapted matching to your automation tasks.

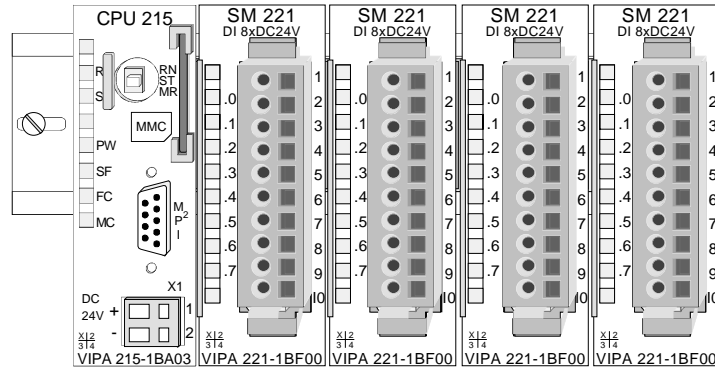

## Components

The System 200V consists of the following components:

- *Head modules* like CPU and bus coupler
- *Periphery modules* like I/O, function und communication modules
- *Power supplies*
- *Extension modules*

## Head modules

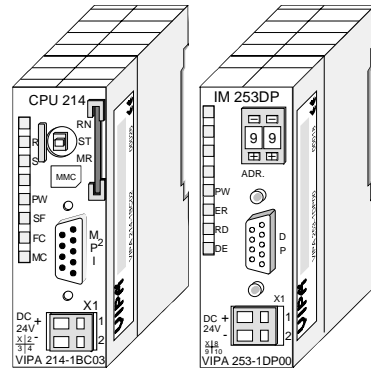

With a head module CPU respectively bus interface and DC 24V power supply are integrated to one casing.

Via the integrated power supply the CPU respectively bus interface is power supplied as well as the electronic of the connected periphery modules.

## Periphery modules

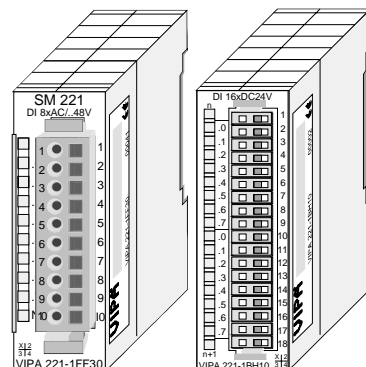

The modules are direct installed on a 35mm profile rail and connected to the head module by a bus connector, which was mounted on the profile rail before.

Most of the periphery modules are equipped with a 10pin respectively 18pin connector. This connector provides the electrical interface for the signaling and supplies lines of the modules.

**Power supplies**

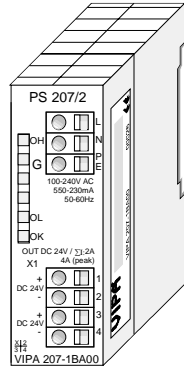

With the System 200V the DC 24V power supply can take place either externally or via a particularly for this developed power supply.

The power supply may be mounted on the profile rail together with the System 200V modules. It has no connector to the backplane bus.

**Expansion modules**

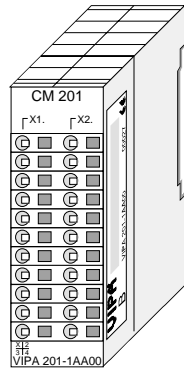

The expansion modules are complementary modules providing 2- or 3wire connection facilities.

The modules are not connected to the backplane bus.

**Structure/ dimensions**

- Profile rail 35mm
- Dimensions of the basic enclosure:
  - 1tier width: (HxWxD) in mm: 76x25.4x74 in inches: 3x1x3
  - 2tier width: (HxWxD) in mm: 76x50.8x74 in inches: 3x2x3

**Installation**

Please note that you can only install head modules, like the CPU, the PC and couplers at slot 1 or 1 and 2 (for double width modules).

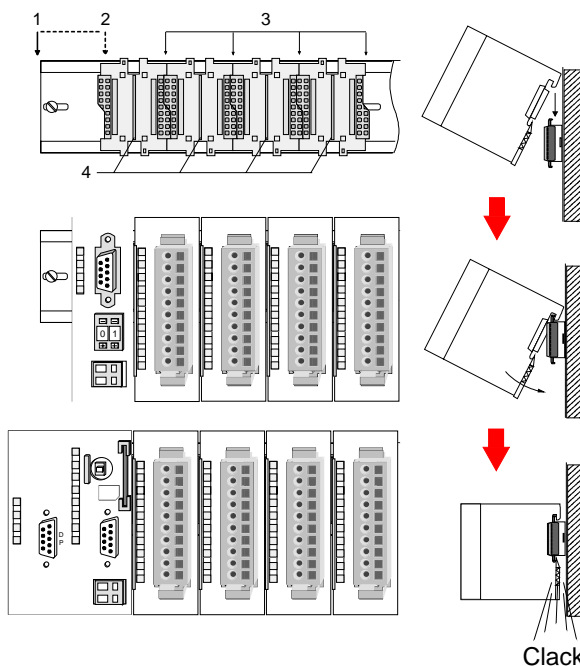

[1]	Head module (double width)
[2]	Head module (single width)
[3]	Periphery module
[4]	Guide rails

**Note**

Information about the max. number of pluggable modules and the max. current at the backplane bus can be found in the "Technical Data" of the according head module.

Please install modules with a high current consumption directly beside the head module.

# Dimensions

**Dimensions**  
**Basic enclosure**

1tier width (HxWxD) in mm: 76 x 25.4 x 74  
2tier width (HxWxD) in mm: 76 x 50.8 x 74

**Installation**  
**dimensions**

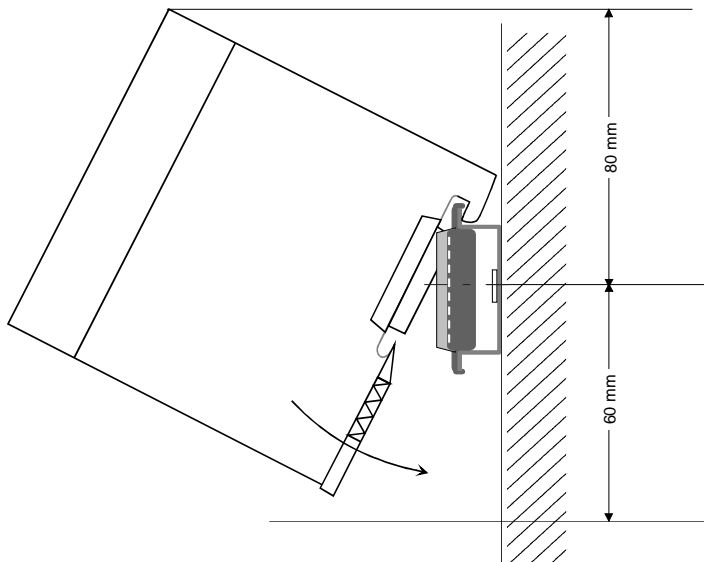

**Installed and wired**  
**dimensions**

In- / Output  
modules

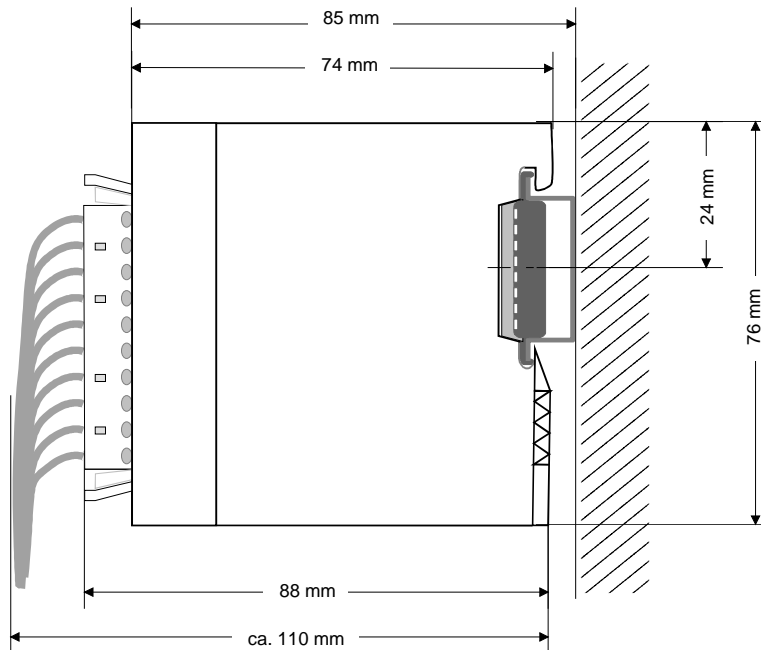

Function modules/  
Extension modules

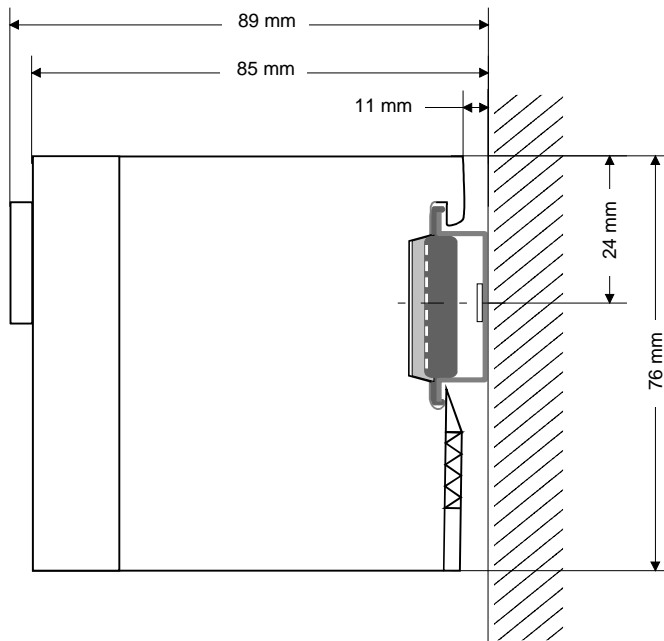

CPUs (here with  
EasyConn from  
VIPA)

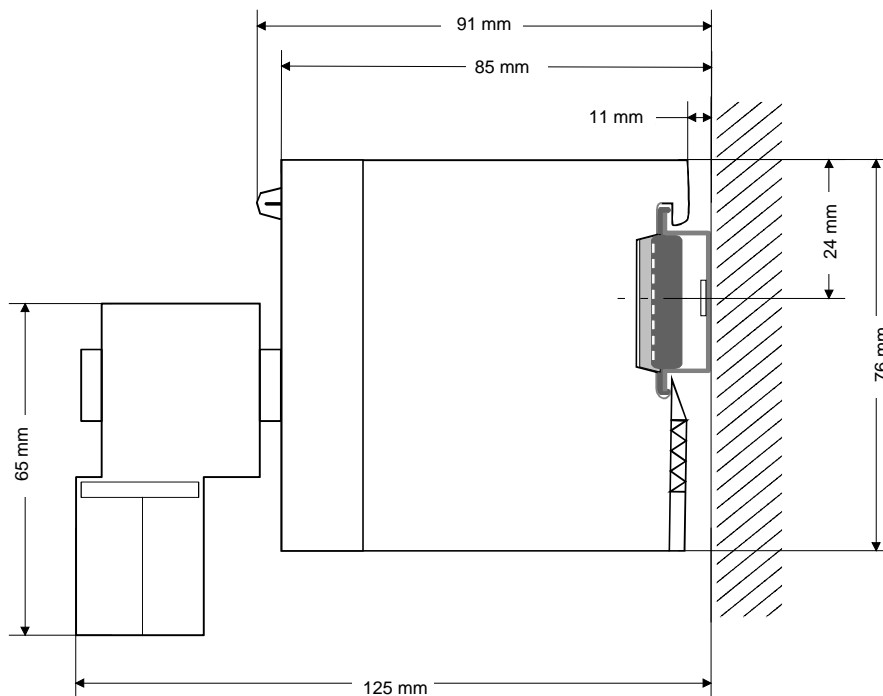

## Installation

### General

The modules are each installed on a 35mm profile rail and connected via a bus connector. Before installing the module the bus connector is to be placed on the profile rail before.

### Profile rail

For installation the following 35mm profile rails may be used:

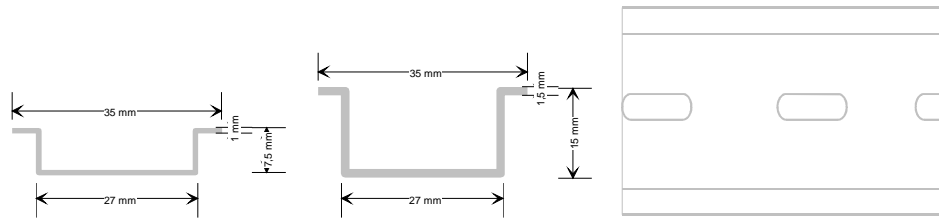

Order number	Label	Description
290-1AF00	35mm profile rail	Length 2000mm, height 15mm
290-1AF30	35mm profile rail	Length 530mm, height 15mm

### Bus connector

System 200V modules communicate via a backplane bus connector. The backplane bus connector is isolated and available from VIPA in of 1-, 2-, 4- or 8tier width.

The following figure shows a 1tier connector and a 4tier connector bus:

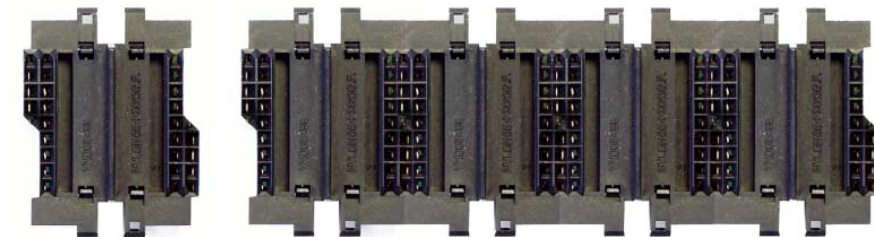

The bus connector is to be placed on the profile rail until it clips in its place and the bus connections look out from the profile rail.

Order number	Label	Description
290-0AA10	Bus connector	1tier
290-0AA20	Bus connector	2tier
290-0AA40	Bus connector	4tier
290-0AA80	Bus connector	8tier

**Installation on a profile rail**

The following figure shows the installation of a 4tier width bus connector in a profile rail and the slots for the modules.

The different slots are defined by guide rails.

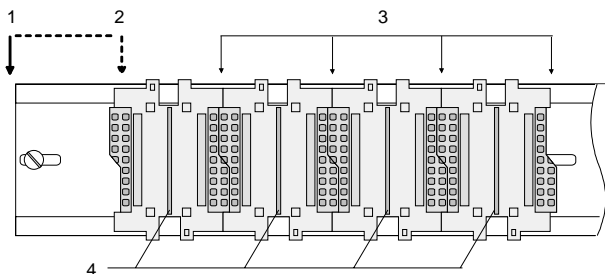

- [1] Head module (double width)
- [2] Head module (single width)
- [3] Peripheral module
- [4] Guide rails

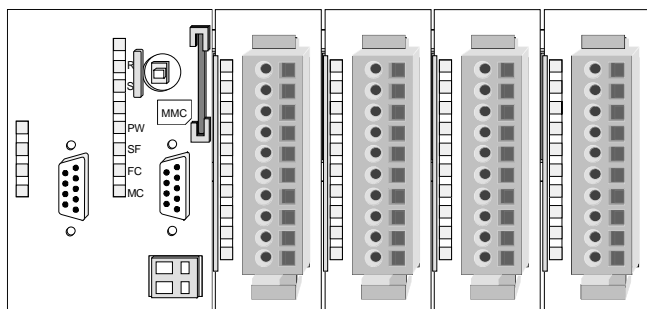
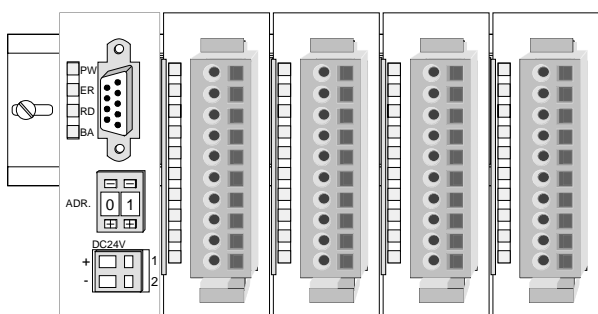

**Assembly regarding the current consumption**

- Use bus connectors as long as possible.
- Sort the modules with a high current consumption right beside the head module. In the service area of [www.vipa.com](http://www.vipa.com) a list of current consumption of every System 200V module can be found.



**Assembly possibilities**

horizontal assembly

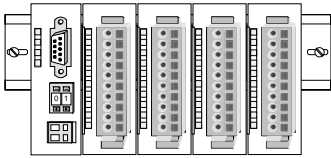

vertical assembly

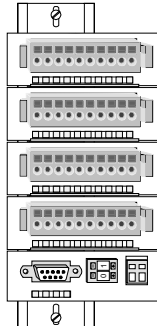

lying assembly

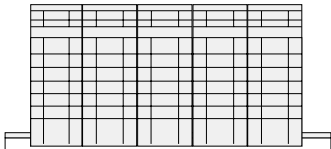

Please regard the allowed environmental temperatures:

- horizontal assembly: from 0 to 60°C
- vertical assembly: from 0 to 40°C
- lying assembly: from 0 to 40°C

The horizontal assembly always starts at the left side with a head module, then you install the peripheral modules beside to the right.

You may install up to 32 peripheral modules.

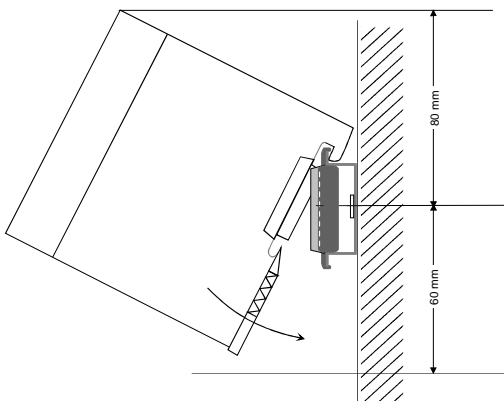

**Please follow these rules during the assembly!**

- Turn off the power supply before you install or remove any modules!
- Make sure that a clearance of at least 60mm exists above and 80mm below the middle of the profile rail.

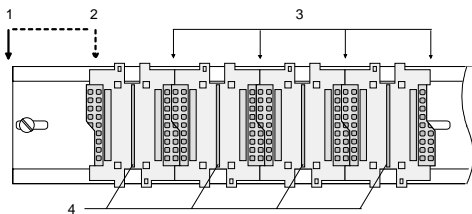

- Every row must be completed from left to right and it has to start with a head module.

- [1] Head module (double width)
- [2] Head module (single width)
- [3] Peripheral modules
- [4] Guide rails

- Modules are to be installed side by side. Gaps are not permitted between the modules since this would interrupt the backplane bus.
- A module is only installed properly and connected electrically when it has clicked into place with an audible click.
- Slots after the last module may remain unoccupied.



**Note!**

Information about the max. number of pluggable modules and the max. current at the backplane bus can be found in the "Technical Data" of the according head module.

Please install modules with a high current consumption directly beside the head module.

**Assembly procedure**

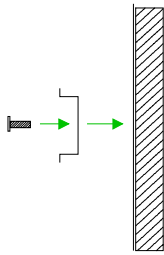

- Install the profile rail. Make sure that a clearance of at least 60mm exists above and 80mm below the middle of the profile rail.

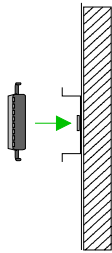

- Press the bus connector into the profile rail until it clips securely into place and the bus-connectors look out from the profile rail. This provides the basis for the installation of your modules.

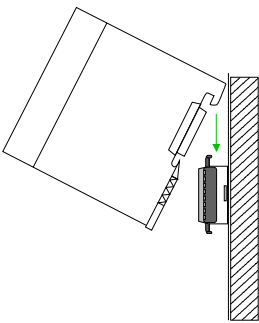

- Start at the outer left location with the installation of your head module and install the peripheral modules to the right of this.

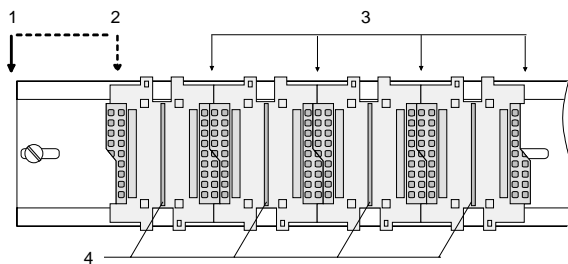

- [1] Head module (double width)
- [2] Head module (single width)
- [3] Peripheral module
- [4] Guide rails

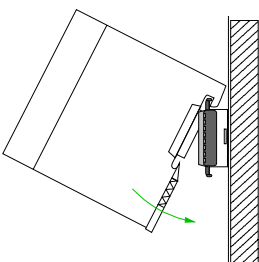

- Insert the module that you are installing into the profile rail at an angle of 45 degrees from the top and rotate the module into place until it clicks into the profile rail with an audible click. The proper connection to the backplane bus can only be guaranteed when the module has properly clicked into place.



**Attention!**

Power must be turned off before modules are installed or removed!

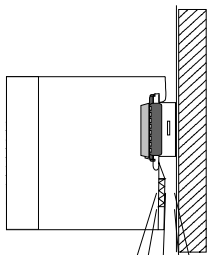

Clack

## Demounting and module exchange

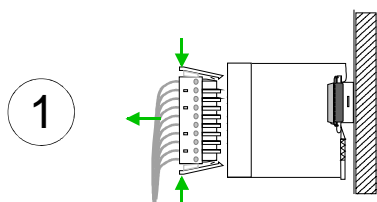

- Remove if exists the wiring to the module, by pressing both locking lever on the connector and pulling the connector.

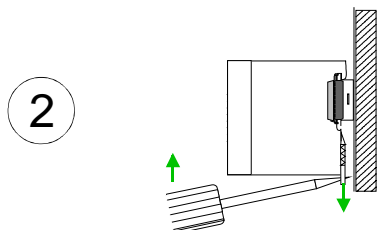

- The casing of the module has a spring loaded clip at the bottom by which the module can be removed.

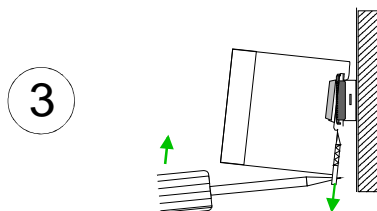

- The clip is unlocked by pressing the screwdriver in an upward direction.

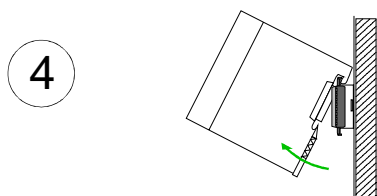

- Withdraw the module with a slight rotation to the top.

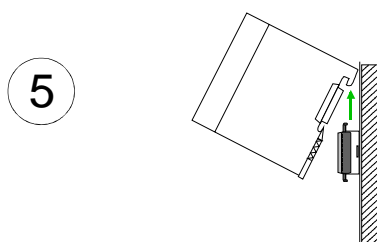

### Attention!

Power must be turned off before modules are installed or removed!

Please regard that the backplane bus is interrupted at the point where the module was removed!

## Wiring

### Overview

Most peripheral modules are equipped with a 10pole or a 18pole connector. This connector provides the electrical interface for the signaling and supply lines of the modules.

The modules carry spring-clip connectors for interconnections and wiring.

The spring-clip connector technology simplifies the wiring requirements for signaling and power cables.

In contrast to screw terminal connections, spring-clip wiring is vibration proof. The assignment of the terminals is contained in the description of the respective modules.

You may connect conductors with a diameter from  $0.08\text{mm}^2$  up to  $2.5\text{mm}^2$  (max.  $1.5\text{mm}^2$  for 18pole connectors).

The following figure shows a module with a 10pole connector.

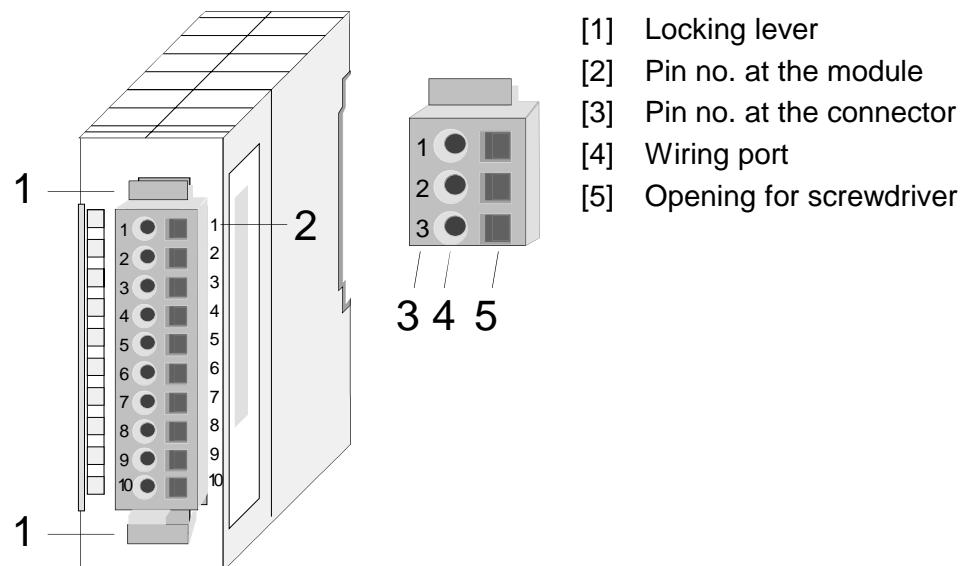

### Note!

The spring-clip is destroyed if you push the screwdriver into the wire port! Make sure that you only insert the screwdriver into the square hole of the connector!

## Wiring procedure

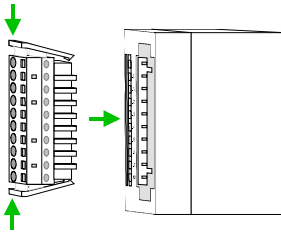

- Install the connector on the module until it locks with an audible click. For this purpose you press the two clips together as shown. The connector is now in a permanent position and can easily be wired.

The following section shows the wiring procedure from top view.

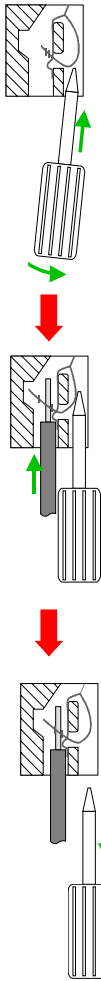

- Insert a screwdriver at an angle into the square opening as shown.
- Press and hold the screwdriver in the opposite direction to open the contact spring.
- Insert the stripped end of the wire into the round opening. You can use wires with a diameter of  $0.08\text{mm}^2$  to  $2.5\text{mm}^2$  ( $1.5\text{mm}^2$  for 18pole connectors).
- By removing the screwdriver the wire is connected safely with the plug connector via a spring.



### Note!

Wire the power supply connections first followed by the signal cables (inputs and outputs).

## Installation guidelines

**General** The installation guidelines contain information about the interference free deployment of System 200V systems. There is the description of the ways, interference may occur in your control, how you can make sure the electromagnetic digestibility (EMC), and how you manage the isolation.

**What means EMC?** Electromagnetic digestibility (EMC) means the ability of an electrical device, to function error free in an electromagnetic environment without being interferenced res. without interfering the environment.  
All System 200V components are developed for the deployment in hard industrial environments and fulfill high demands on the EMC. Nevertheless you should project an EMC planning before installing the components and take conceivable interference causes into account.

**Possible interference causes** Electromagnetic interferences may interfere your control via different ways:

- Fields
- I/O signal conductors
- Bus system
- Current supply
- Protected earth conductor

Depending on the spreading medium (lead bound or lead free) and the distance to the interference cause, interferences to your control occur by means of different coupling mechanisms.

One differs:

- galvanic coupling
- capacitive coupling
- inductive coupling
- radiant coupling

**Basic rules for EMC**

In the most times it is enough to take care of some elementary rules to guarantee the EMC. Please regard the following basic rules when installing your PLC.

- Take care of a correct area-wide grounding of the inactive metal parts when installing your components.
  - Install a central connection between the ground and the protected earth conductor system.
  - Connect all inactive metal extensive and impedance-low.
  - Please try not to use aluminum parts. Aluminum is easily oxidizing and is therefore less suitable for grounding.
- When cabling, take care of the correct line routing.
  - Organize your cabling in line groups (high voltage, current supply, signal and data lines).
  - Always lay your high voltage lines and signal res. data lines in separate channels or bundles.
  - Route the signal and data lines as near as possible beside ground areas (e.g. suspension bars, metal rails, tin cabinet).
- Proof the correct fixing of the lead isolation.
  - Data lines must be laid isolated.
  - Analog lines must be laid isolated. When transmitting signals with small amplitudes the one sided laying of the isolation may be favorable.
  - Lay the line isolation extensively on an isolation/protected earth conductor rail directly after the cabinet entry and fix the isolation with cable clamps.
  - Make sure that the isolation/protected earth conductor rail is connected impedance-low with the cabinet.
  - Use metallic or metalized plug cases for isolated data lines.
- In special use cases you should appoint special EMC actions.
  - Wire all inductivities with erase links.
  - Please consider luminescent lamps can influence signal lines.
- Create a homogeneous reference potential and ground all electrical operating supplies when possible.
  - Please take care for the targeted employment of the grounding actions. The grounding of the PLC is a protection and functionality activity.
  - Connect installation parts and cabinets with the System 200V in star topology with the isolation/protected earth conductor system. So you avoid ground loops.
  - If potential differences between installation parts and cabinets occur, lay sufficiently dimensioned potential compensation lines.

**Isolation of conductors**

Electrical, magnetically and electromagnetic interference fields are weakened by means of an isolation, one talks of absorption.

Via the isolation rail, that is connected conductive with the rack, interference currents are shunt via cable isolation to the ground. Hereby you have to make sure, that the connection to the protected earth conductor is impedance-low, because otherwise the interference currents may appear as interference cause.

When isolating cables you have to regard the following:

- If possible, use only cables with isolation tangle.
- The hiding power of the isolation should be higher than 80%.
- Normally you should always lay the isolation of cables on both sides. Only by means of the both-sided connection of the isolation you achieve high quality interference suppression in the higher frequency area.  
Only as exception you may also lay the isolation one-sided. Then you only achieve the absorption of the lower frequencies. A one-sided isolation connection may be convenient, if:
  - the conduction of a potential compensating line is not possible
  - analog signals (some mV res.  $\mu$ A) are transferred
  - foil isolations (static isolations) are used.
- With data lines always use metallic or metalized plugs for serial couplings. Fix the isolation of the data line at the plug rack. Do not lay the isolation on the PIN 1 of the plug bar!
- At stationary operation it is convenient to strip the insulated cable interruption free and lay it on the isolation/protected earth conductor line.
- To fix the isolation tangles use cable clamps out of metal. The clamps must clasp the isolation extensively and have well contact.
- Lay the isolation on an isolation rail directly after the entry of the cable in the cabinet. Lead the isolation further on to the System 200V module and **don't** lay it on there again!

**Please regard at installation!**

At potential differences between the grounding points, there may be a compensation current via the isolation connected at both sides.

Remedy: Potential compensation line.



## General data

### Structure/ dimensions

- Profile rail 35mm
- Peripheral modules with recessed labelling
- Dimensions of the basic enclosure:  
1tier width: (HxWxD) in mm: 76x25.4x74 in inches: 3x1x3  
2tier width: (HxWxD) in mm: 76x50.8x74 in inches: 3x2x3

### Reliability

- Wiring by means of spring pressure connections (CageClamps) at the front-facing connector, core cross-section 0.08 ... 2.5mm<sup>2</sup> or 1.5mm<sup>2</sup> (18pole plug)
- Complete isolation of the wiring when modules are exchanged
- Every module is isolated from the backplane bus

## General data

Conformity and approval		
Conformity		
CE	2006/95/EC	Low-voltage directive
	2004/108/EC	EMC directive
Approval		
UL	UL 508	Approval for USA and Canada
others		
RoHS	2011/65/EU	Product is lead-free; Restriction of the use of certain hazardous substances in electrical and electronic equipment

Protection of persons and device protection		
Type of protection	-	IP20
Electrical isolation		
to the field bus	-	electrically isolated
to the process level	-	electrically isolated
Insulation resistance	EN 61131-2	-
Insulation voltage to reference earth		
Inputs / outputs	-	AC / DC 50V, test voltage AC 500V
Protective measures	-	against short circuit

Environmental conditions to EN 61131-2		
Climatic		
Storage / transport	EN 60068-2-14	-25...+70°C
Operation		
Horizontal installation	EN 61131-2	0...+60°C
Vertical installation	EN 61131-2	0...+60°C
Air humidity	EN 60068-2-30	RH1 (without condensation, rel. humidity 10...95%)
Pollution	EN 61131-2	Degree of pollution 2
<b>Mechanical</b>		
Oscillation	EN 60068-2-6	1g, 9Hz ... 150Hz
Shock	EN 60068-2-27	15g, 11ms

Mounting conditions		
Mounting place	-	In the control cabinet
Mounting position	-	Horizontal and vertical

EMC	Standard	Comment
Emitted interference	EN 61000-6-4	Class A (Industrial area)
Noise immunity zone B	EN 61000-6-2	Industrial area
	EN 61000-4-2	ESD 8kV at air discharge (degree of severity 3), 4kV at contact discharge (degree of severity 2)
	EN 61000-4-3	HF field immunity (casing) 80MHz ... 1000MHz, 10V/m, 80% AM (1kHz) 1.4GHz ... 2.0GHz, 3V/m, 80% AM (1kHz) 2GHz ... 2.7GHz, 1V/m, 80% AM (1kHz)
	EN 61000-4-6	HF conducted 150kHz ... 80MHz, 10V, 80% AM (1kHz)
	EN 61000-4-4	Burst, degree of severity 3
	EN 61000-4-5	Surge, installation class 3 *)

\*) Due to the high-energetic single pulses with Surge an appropriate external protective circuit with lightning protection elements like conductors for lightning and overvoltage is necessary.

## Chapter 2 Power supplies - PS

**Overview** This chapter contains descriptions of the System 200V power supplies.

<b>Contents</b>	<b>Topic</b>	<b>Page</b>
	<b>Chapter 2 Power supplies - PS</b> .....	<b>2-1</b>
	Safety precautions .....	2-2
	System overview .....	2-3
	PS 207/2 - Power supply - Structure .....	2-4
	PS 207/2CM - Power supply with Clamps - Structure.....	2-6
	Installation .....	2-8
	Cabling.....	2-9
	Technical data.....	2-10

## Safety precautions

### Appropriate use

The power supplies were designed and constructed:

- to supply DC 24V to the System 200V components
- to be installed on a t-rail along with System 200V components
- to operate as DC 24V stand-alone power supply
- for installation in a cabinet with sufficient ventilation
- for industrial applications

**The following precautions apply to applications employing the System 200V power supplies.**



### Danger!

- The power supplies must be installed in protected environments that are only accessible to properly qualified maintenance staff!
- The power supplies are not certified for applications in explosive environments (EX-zone)!
- You have to disconnect the power supply from the main power source before commencing installation or maintenance work, i.e. before you start to work on a power supply or the supply cable the main supply line must be disconnected (disconnect plugs, on permanent installations the respective fuse has to be turned off)!
- Only properly qualified electrical staff is allowed to install, connect and/or modify electrical equipment!
- To provide a sufficient level of ventilation and cooling to the power supply components whilst maintaining the compact construction it was not possible to protect the unit from incorrect handling and a proper level of fire protection. For this reason the required level of fire protection must be provided by the environment where the power supply is installed (e.g. installation in a switchboard that satisfies the fire protection rules and regulations)!
- Please adhere to the national rules and regulations of the location and/or country where the units are installed (installation, safety precautions, EMC ...).

## System overview

The System 200V power supplies are provided with a wide-range input that is connectable to AC 100 ... 240V. The output voltage is DC 24V at 2A/48W.

Since all inputs and outputs are located on the front of the unit and since the enclosure is isolated from the backplane bus you may install the power supply along with the System 200V on the same t-rail or you can use it as a separate external power supply.

The following power supplies are currently available:

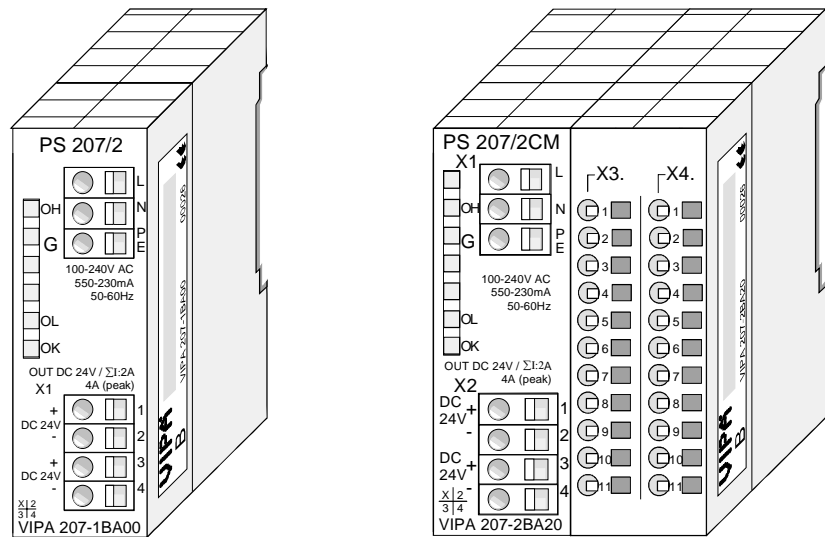

### Order data

Order number	Description
207-1BA00	Power supply PS 207/2 primary AC 100...240V, secondary DC 24V, 2A, 48W
207-2BA20	Power supply PS 207/2CM primary AC 100...240V, secondary DC 24V, 2A, 48W with terminal module 2x11 clamps

## PS 207/2 - Power supply - Structure

### Properties

The power supply is distinguished by the following properties:

- Wide-range input AC 100 ... 240V without manual intervention
- Output voltage DC 24V, 2A, 48W
- Installable on a t-rail together with other System 200V components
- Protection from short-circuits, overload and open circuits
- Typically 90% efficiency at  $I_{rated}$

### Structure

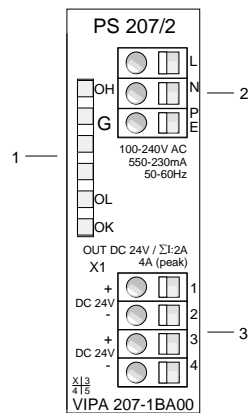

- [1] LED status indicator
- [2] AC IN 100 ... 240V
- [3] DC OUT 24V, 2A, 48W

### LEDs

The front of the power supply carries 3 LEDs for troubleshooting purposes. The following table lists the significance and the respective color.

Name	Color	Description
OH	red	Overheat: turned on by excessive temperatures
OL	yellow	Overload: turned on when the total current exceeds the maximum capacity of app. 3A.
OK	green	Turned on when the power supply operates properly and supplies DC 24V power.



#### Note!

Only one LED is on at unit operation.

When all the LEDs are extinguished while the power supply is operational, a short circuit is present or the power supply has failed.

**Connector wiring**

**Input voltage**  
**INPUT**  
**AC 100...240V**

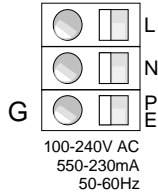

The power supply must be connected to a source of AC power via the input connector.

A fuse protects the input from overloads.

**Line protection**

To protect the main supply lines, you should install a miniature circuitbreaker of the following rating:

- Rated current at AC 230V: 6A
- Tripping characteristics: C

**Output voltage**  
**OUTPUT**  
**DC 24V, 2A**

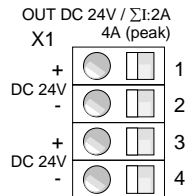

Two connectors are provided for connection to System 200V modules that require an external source of DC 24V .

Both outputs are protected against short circuits and have an output voltage of DC 24V with a total current of 2A max.

**Block diagram**

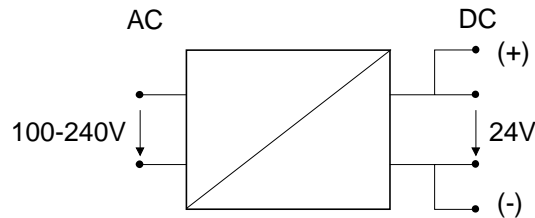

**Danger!**

- You need to disconnect the power supply from the main power source before commencing installation or maintenance work, i.e. before you start to work on a power supply or the supply cable, the main supply line must be disconnected (disconnect plugs, on permanent installations, the respective fuse has to be turned off)!
- Only properly qualified electrical staff is allowed to install, connect and/or modify electrical equipment!

## PS 207/2CM - Power supply with Clamps - Structure

### Properties

The power supply is distinguished by the following properties:

- Wide-range input AC 100 ... 240V without manual intervention
- Output voltage DC 24V, 2A, 48W
- Installable on a t-rail together with other System 200V components
- Protection from short-circuits, overload and open circuits
- Typically 90% efficiency at  $I_{rated}$
- Terminal module with 2x11 clamps

### Structure

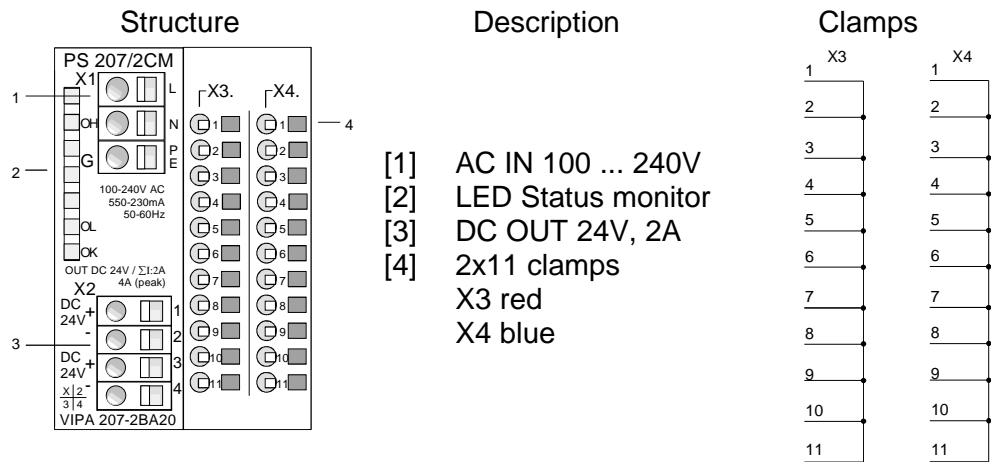

### LEDs

The front of the power supply carries 3 LEDs for troubleshooting purposes. The following table lists the significance and the respective color.

Name	Color	Description
OH	red	Overheat: turned on by excessive temperatures
OL	yellow	Overload: turned on when the total current exceeds the maximum capacity of app. 3A.
OK	green	Turned on when the power supply operates properly and supplies DC 24V power.



### Note!

Only one LED is on at unit operation.

When all the LEDs are extinguished while the power supply is operational, a short circuit is present or the power supply has failed.



## Connector wiring

### Input voltage INPUT AC 100...240V

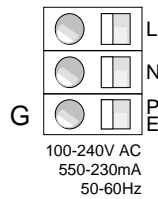

The power supply has to be connected to a source of AC power via the input connector.

A fuse protects the input from overloads.

### Line protection

To protect the main supply lines, you should install a miniature circuitbreaker of the following rating:

- Rated current at AC 230V: 6A
- Tripping characteristics: C

### Output voltage OUTPUT DC 24V, 4A

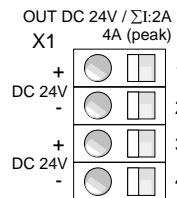

Two connectors are provided for connection to System 200V modules that require an external source of DC 24V.

Both outputs are protected against short circuits protected and have an output voltage of DC 24V with a total current of max. 2A.

### Block diagram

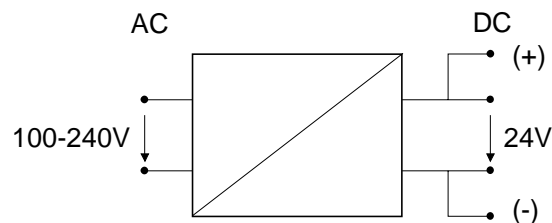

### Danger!

- You need to disconnect the power supply from the main power source before commencing installation or maintenance work, i.e. before you start to work on a power supply or the supply cable the main supply line has to be disconnected (disconnect plugs, on permanent installations the respective fuse must be turned off)!
- Only properly qualified electrical staff is allowed to install, connect and/or modify electrical equipment!

## Installation

### Installation

You may install the power supply along with System 200V modules on the same T-rail. In this case the power supply can only be installed at one end of your System 200V since the backplane bus would otherwise be interrupted.

The power supplies are not connected to the backplane bus.

Please ensure proper and sufficient ventilation for the power supply when you select the installation location.



### Danger!

- The power supplies have to be installed in protected environments that are only accessible to properly qualified maintenance staff!
- You need to disconnect the power supply from the main power source before commencing installation or maintenance work, i.e. before you start to work on a power supply or the supply cable, the main supply line must be disconnected (disconnect plugs, on permanent installations, the respective fuse must be turned off)!
- Only properly qualified electrical staff is allowed to install, connect and/or modify electrical equipment!
- To provide a sufficient level of ventilation and cooling to the power supply components whilst maintaining the compact construction, it was not possible to protect the unit from incorrect handling and a proper level of fire protection. For this reason the required level of fire protection must be provided by the environment where the power supply is installed (e.g. installation in a switchboard that satisfies the fire protection rules and regulations)!
- Please adhere to the national rules and regulations of the location and/or country where the units are installed (installation, safety precautions, EMC ...).

# Cabling

## Overview

The Co Power Supply is exclusively delivered with CageClamp contacts. Here the DC 24V power supply may be connected.



### Danger!

- Before installation or overhauling, the power supplies must be disconnected from voltage (pull the plug or remove the fuse)!
- Installation and modifications only by properly trained personnel!

## CageClamp technology (gray)

For the cabling gray connectors with CageClamp technology are used.

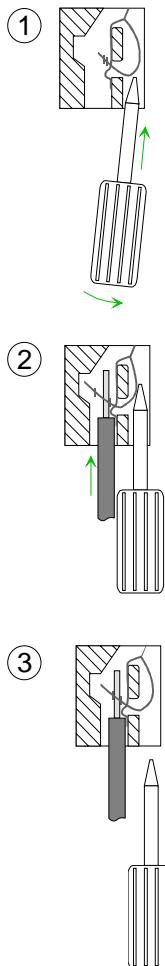

You may connect wires with a cross-section of 0.08mm<sup>2</sup> to 2.5mm<sup>2</sup>. You can use flexible wires without end case as well as stiff wires.

You fix the conductors to the CageClamps like this:

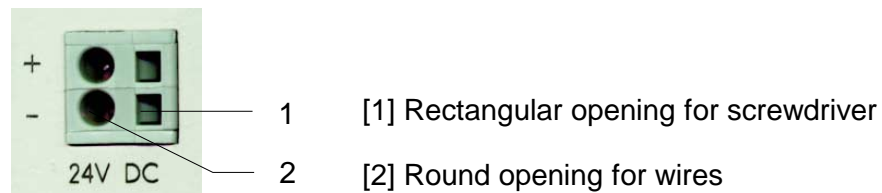

The picture on the left side shows the cabling step by step from top view.

- To conduct a wire you plug a fitting screwdriver obliquely into the rectangular opening like shown in the picture.
- To open the contact spring you have to push the screwdriver in the opposite direction and hold it.
- Insert the insulation striped wire into the round opening. You may use wires with a cross-section from 0.08mm<sup>2</sup> to 2.5mm<sup>2</sup>.
- By removing the screwdriver the wire is connected safely with the plug connector via a spring.

## Technical data

### Power supply PS 207/2, 2A, 48W

<b>Order no.</b>	<b>207-1BA00</b>
Type	PS 207
<b>Technical data power supply</b>	
Input voltage (rated value)	AC 100...240 V
Input voltage (permitted range)	AC 100...240 V
Mains frequency (rated value)	50...60 Hz
Mains frequency (permitted range)	47...63 Hz
Input current (at 120 V)	0.53 A
Input current (at 230 V)	0.24 A
Inrush current (at 25 °C)	30 A
$I^2t$	1A <sup>2</sup> s
Power consumption typ.	53 W
Output voltage (rated value)	24 V
Output current (rated value)	2 A
Power supply parallel switchable	✓
Protect type	Short circuit, overload, over temperature
Ripple of output voltage (max.), BW=20 MHz	100 mV
Efficiency typ.	90 %
Power loss typ.	5 W
<b>Clamp parameter</b>	
Terminal voltage max.	-
Terminal current max.	-
<b>Status information, alarms, diagnostics</b>	
Status display	yes
Interrupts	no
Process alarm	no
Diagnostic interrupt	no
Diagnostic functions	no
Diagnostics information read-out	none
Supply voltage display	none
Group error display	none
Channel error display	none
<b>Housing</b>	
Material	PPE / PA 6.6
Mounting	Profile rail 35 mm
<b>Mechanical data</b>	
Dimensions (WxHxD)	25.4 x 76 x 78 mm
Weight	150 g
<b>Environmental conditions</b>	
Operating temperature	0 °C to 60 °C
Storage temperature	-25 °C to 70 °C
<b>Certifications</b>	
UL508 certification	-

**Power supply  
PS 207/2CM,  
2A, 48W**

<b>Order no.</b>	<b>207-2BA20</b>
Type	PS 207
<b>Technical data power supply</b>	
Input voltage (rated value)	AC 100...240 V
Input voltage (permitted range)	AC 100...240 V
Mains frequency (rated value)	50...60 Hz
Mains frequency (permitted range)	47...63 Hz
Input current (at 120 V)	0.53 A
Input current (at 230 V)	0.24 A
Inrush current (at 25 °C)	30 A
$I^2t$	1A <sup>2</sup> s
Power consumption typ.	53 W
Output voltage (rated value)	24 V
Output current (rated value)	2 A
Power supply parallel switchable	✓
Protect type	Short circuit, overload, over temperature
Ripple of output voltage (max.), BW=20 MHz	100 mV
Efficiency typ.	90 %
Power loss typ.	5 W
<b>Clamp parameters</b>	
Terminal voltage max.	DC 60 V
Terminal current max.	10 A
Potential group	
number of clamps	11
colour of clamp	red
binding of potential	unbound
potential group current, max.	10 A
Potential group	
number of clamps	11
colour of clamp	blue
binding of potential	unbound
potential group current, max.	10 A
<b>Status information, alarms, diagnostics</b>	
Status display	yes
Interrupts	no
Process alarm	no
Diagnostic interrupt	no
Diagnostic functions	no
Diagnostics information read-out	none
Supply voltage display	none
Group error display	none
Channel error display	none
<b>Housing</b>	
Material	PPE / PA 6.6
Mounting	Profile rail 35 mm
<b>Mechanical data</b>	
Dimensions (WxHxD)	50.8 x 76 x 78 mm
Weight	210 g
<b>Environmental conditions</b>	
Operating temperature	0 °C to 60 °C
Storage temperature	-25 °C to 70 °C
<b>Certifications</b>	
UL508 certification	-



## Chapter 3 System expansion modules - CM

### Overview

The chapter contains a description of additional components that are available from VIPA for the System 200V.

The general overview is followed by the description of the 4port fast Ethernet mini switch. This module completes the System 200V network technology.

The chapter concludes with the terminal modules. These modules provide connection facilities for signaling cables as well as supply voltages for your System 200V.

### Contents

Topic	Page
<b>Chapter 3 System expansion modules - CM</b> .....	<b>3-1</b>
System overview .....	3-2
CM 240 - 4port mini switch .....	3-3
CM 201 - Terminal modules .....	3-6

## System overview

### 4port mini switch

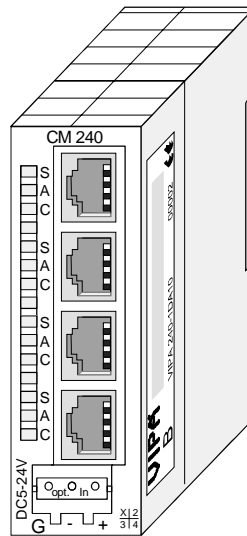

### Ordering data 4port mini switch

Type	Order number	Description
CM 240	240-1DA10	4port mini switch
	970-0CM00	optional front-facing connector at external power supply DC 5-24V

### Terminal module

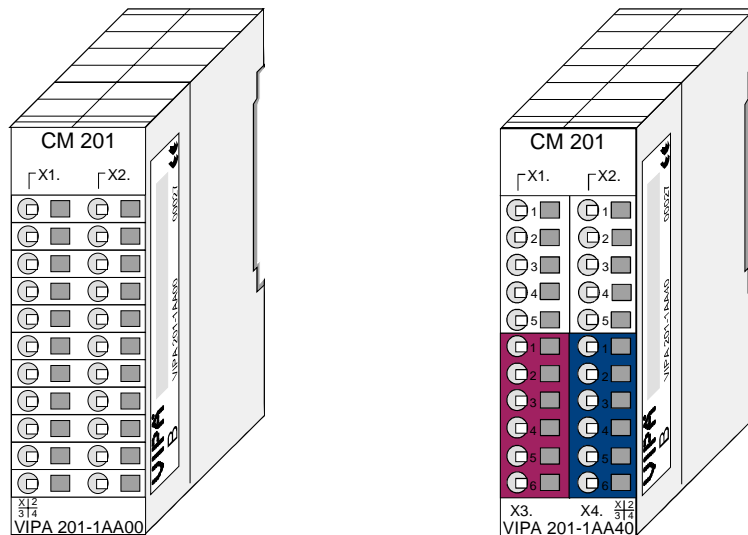

### Ordering data terminal modules

Type	Order number	Description
CM 201	201-1AA00	Dual terminals gray/gray
CM 201	201-1AA10	Dual terminals green-yellow/gray
CM 201	201-1AA20	Dual terminals red/blue
CM 201	201-1AA40	Quad terminals gray/red/blue



## CM 240 - 4port mini switch

**Ordering data**      4port mini switch CM 240      240-1DA10  
**Attention: the 4port mini switch had the order no. 243-1DA10 before!**

**Overview**      The 4port mini switch completes the System 200V network technology. Auto-Negotiation, Speed-Auto-Sensing and the Auto-MDI/MDIX-Crossover for every port enable the module for "plug & play". The module is provided with the needed operating voltage via the backplane bus. Alternatively you may supply the module via the front. The status indication of the 4 ports happens via LEDs on the front side.

- Properties**
- 4 ports for 10 res. 100MBit/s,
  - "plug and play" through Auto-MDI/MDIX-crossover for 100BASE-TX and 10BASE-T,
  - Auto-Negotiation and Speed-Auto-Sensing
  - for every port automatic switch between 10 and 100MBit/s res. half- and full-duplex operation
  - LEDs for activity, speed and collision
  - Supports IEEE 802.3, IEEE 802.3u and IEEE 802.3x
  - Extra high performance up to 150m at UTP (unscreened twisted-pair cable)
  - Back-pressure-based flow control at half-duplex operation
  - Pause-frame-based flow control at full-duplex operation
  - Store-and-forward switching mode
  - Shared memory based switch

**Front view  
 CM 240**

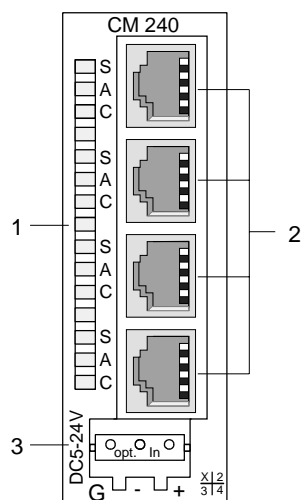

- [1] LED Status monitoring
- [2] twisted-pair Ports for Ethernet
- [3] Power supply external

**Components**

**LEDs**

For every twisted-pair jack there are 3 LEDs at the front side. The LEDs have the following function:

Name	Color	Function	Description
S	green	Speed	on: 100MBit, off: 10MBit
A	yellow	Activity	on: physically connected, off: no physical connection blinking: shows bus activity
C	yellow	Collision	on: full-duplex operation active, off: half-duplex operation active blinking: Collision detected

**Power supply**

The power supply takes place via the backplane bus of the System 200V. You may also deploy the switch as stand-alone device. Here you have to provide it with external DC 5...24V.

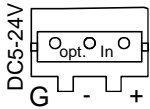

The plug for connecting an external power supply is under a flap that you have to break out.

For connecting an external power supply there is a connection jack available from VIPA under the order number 970-0CM00.



**Attention!**

The power supply has to take place either internal via backplane bus or external. **A simultaneous supply must be avoided!**

**Twisted-pair ports**

The twisted-pair jacks are used to build-up a twisted-pair network in star topology. This allows you to connect up to 4 Ethernet components, where 1 connection has to be deployed as uplink port to the ongoing network. The uplink port is detected automatically.

**Technical data**

<b>Order no.</b>	<b>240-1DA10</b>
Type	CM 240, 4port Mini-Switch
<b>Current consumption/power loss</b>	
Current consumption from backplane bus	450 mA
Power loss	2 W
<b>Status information, alarms, diagnostics</b>	
Status display	yes
Interrupts	no
Process alarm	no
Diagnostic interrupt	no
Diagnostic functions	no
Diagnostics information read-out	none
Supply voltage display	none
Group error display	none
Channel error display	none
<b>Functionality Sub-D interfaces</b>	

<b>Order no.</b>	<b>240-1DA10</b>
Type	-
Type of interface	-
Connector	-
Electrically isolated	-
MPI	-
MP2I (MPI/RS232)	-
DP master	-
DP slave	-
Point-to-point interface	-
<b>Point-to-point communication</b>	
PtP communication	-
Interface isolated	✓
RS232 interface	-
RS422 interface	-
RS485 interface	-
Connector	RJ45
Transmission speed, min.	10 Mbit/s
Transmission speed, max.	100 Mbit/s
Cable length, max.	-
<b>Point-to-point protocol</b>	
ASCII protocol	-
STX/ETX protocol	-
3964(R) protocol	-
RK512 protocol	-
USS master protocol	-
Modbus master protocol	-
Modbus slave protocol	-
Special protocols	-
<b>Datasizes</b>	
Input bytes	-
Output bytes	-
Parameter bytes	-
Diagnostic bytes	-
<b>Housing</b>	
Material	PPE / PA 6.6
Mounting	Profile rail 35 mm
<b>Mechanical data</b>	
Dimensions (WxHxD)	25.4 x 76 x 78 mm
Weight	50 g
<b>Environmental conditions</b>	
Operating temperature	0 °C to 60 °C
Storage temperature	-25 °C to 70 °C
<b>Certifications</b>	
UL508 certification	yes

## CM 201 - Terminal modules

### 2 x 11 pole

The terminal module is available under order no.: 201-1AAxx.

This module is a complementary module providing 2- or 3wire connection facilities. The module is not connected to the system bus.

### Properties

- 2 separate rows of 11 electrically interconnected terminals.
- No connection to the system bus.
- Maximum terminal current 10A.

### Construction and schematic diagram

#### Construction

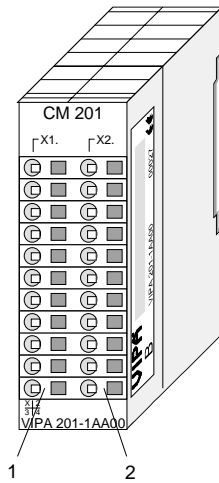

#### Description

- [1] 1. terminal strip
- [2] 2. terminal strip

#### Schematic diagram

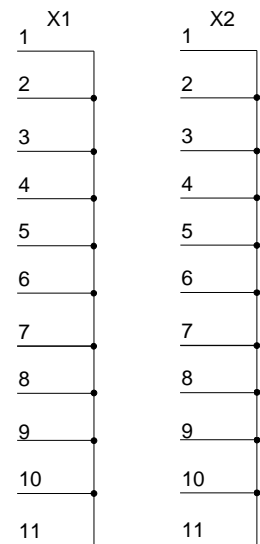

## Technical data

<b>Order no.</b>	<b>201-1AA00</b>
Type	CM 201
<b>Clamp parameter</b>	
Terminal voltage max.	DC 60 V
Terminal current max.	10 A
Total current per module, max.	20 A
<b>Isolated group</b>	
Number of clamps	11
Colour of clamp	grey
Binding of potential	unbound
Potential group current, max.	10 A
<b>Isolated group</b>	
Number of clamps	11
Colour of clamp	grey
Binding of potential	unbound
Potential group current, max.	10 A
<b>Housing</b>	
Material	PPE / PA 6.6
Mounting	Profile rail 35 mm
<b>Mechanical data</b>	
Dimensions (WxHxD)	25.4 x 76 x 80 mm
Weight	90 g
<b>Environmental conditions</b>	
Operating temperature	0 °C to 60 °C
Storage temperature	-25 °C to 70 °C
<b>Certifications</b>	
UL508 certification	yes

<b>Order no.</b>	<b>201-1AA10</b>
Type	CM 201
<b>Clamp parameter</b>	
Terminal voltage max.	DC 60 V
Terminal current max.	10 A
Total current per module, max.	20 A
<b>Isolated group</b>	
Number of clamps	11
Colour of clamp	green/yellow
Binding of potential	unbound
Potential group current, max.	10 A
<b>Isolated group</b>	
Number of clamps	11
Colour of clamp	grey
Binding of potential	unbound
Potential group current, max.	10 A
<b>Housing</b>	
Material	PPE / PA 6.6
Mounting	Profile rail 35 mm
<b>Mechanical data</b>	
Dimensions (WxHxD)	25.4 x 76 x 80 mm
Weight	90 g
<b>Environmental conditions</b>	
Operating temperature	0 °C to 60 °C
Storage temperature	-25 °C to 70 °C
<b>Certifications</b>	
UL508 certification	yes

<b>Order no.</b>	<b>201-1AA20</b>
Type	CM 201
<b>Clamp parameter</b>	
Terminal voltage max.	DC 60 V
Terminal current max.	10 A
Total current per module, max.	20 A
<b>Isolated group</b>	
Number of clamps	11
Colour of clamp	red
Binding of potential	unbound
Potential group current, max.	10 A
<b>Isolated group</b>	
Number of clamps	11
Colour of clamp	blue
Binding of potential	unbound
Potential group current, max.	10 A
<b>Housing</b>	
Material	PPE / PA 6.6
Mounting	Profile rail 35 mm
<b>Mechanical data</b>	
Dimensions (WxHxD)	25.4 x 76 x 80 mm
Weight	90 g
<b>Environmental conditions</b>	
Operating temperature	0 °C to 60 °C
Storage temperature	-25 °C to 70 °C
<b>Certifications</b>	
UL508 certification	yes

**2 x 5 pole**  
**2 x 6 pole**

The terminal module has the order no: 201-1AA40.

This module is a complementary module providing 2- or 3wire connection facilities. The module is not connected to the system bus.

**Properties**

- 4 separate rows with 2 x 5 and 2 x 6 electrically interconnected terminals
- No connection to the system bus
- Maximum terminal current 10A

**Construction and schematic diagram**

**Construction**

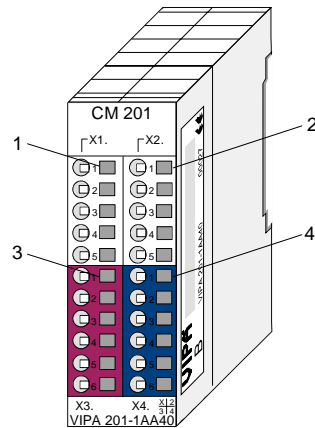

**Description**

- [1] 1. terminal strip
- [2] 2. terminal strip
- [3] 3. terminal strip
- [4] 4. terminal strip

**Schematic diagram**

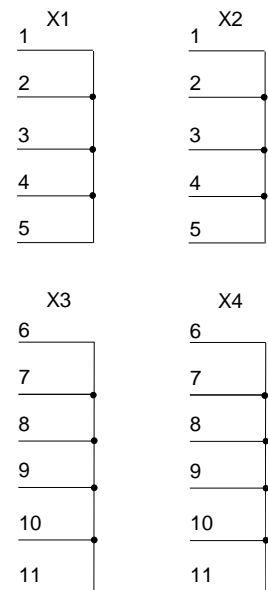

## Technical data

<b>Order no.</b>	<b>201-1AA40</b>
Type	CM 201
<b>Clamp parameter</b>	
Terminal voltage max.	DC 60 V
Terminal current max.	10 A
Total current per module, max.	40 A
<b>Isolated group</b>	
Number of clamps	5
Colour of clamp	grey
Binding of potential	unbound
Potential group current, max.	10 A
<b>Isolated group</b>	
Number of clamps	5
Colour of clamp	grey
Binding of potential	unbound
Potential group current, max.	10 A
<b>Isolated group</b>	
Number of clamps	6
Colour of clamp	red
Binding of potential	unbound
Potential group current, max.	10 A
<b>Isolated group</b>	
Number of clamps	6
Colour of clamp	blue
Binding of potential	unbound
Potential group current, max.	10 A
<b>Housing</b>	
Material	PPE / PA 6.6
Mounting	Profile rail 35 mm
<b>Mechanical data</b>	
Dimensions (WxHxD)	25.4 x 76 x 80 mm
Weight	90 g
<b>Environmental conditions</b>	
Operating temperature	0 °C to 60 °C
Storage temperature	-25 °C to 70 °C
<b>Certifications</b>	
UL508 certification	yes