

# RV Series Standard/ Low Power Solenoid Valve (5/2,5/3 way)

## RV

### Standard/ Low Power Solenoid Valve (5/2,5/3 way)

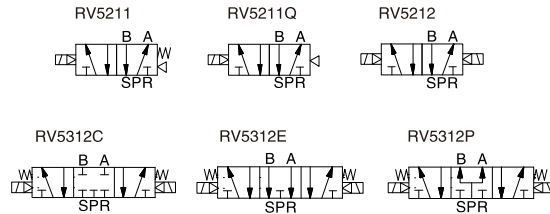

### How to Order?

#### Low Power Solenoid Valve

Series No.	Valve body size	ID Code	Positions	Ways	Controls	Original Status	Port Size	Reset Form	Voltage	Connection Mode	Cover Color	Acting Type	Patchcord	Thread Type
N	1: 1Series 2: 2Series 3: 3Series 4: 4Series	R: Standard armature +Energy saving coil	2: 2 positions 3: 3 positions	5: 5 ways	1: Single control 2: Double control	C: Center close P: Center pressure E: Center exhaust (Only for 5/3 way)	M5: M5 06: 1/8" 08: 1/4" 10: 3/8" 15: 1/2"	Blank: Spring Q: Air (Only single control)	E1: AC110V E2: AC220V E4: DC24V (1 Series only DC24V)	Blank: DIN connector type L: Plug-in type K: Water proof connector type (only for 2,3,4 series)	Blank: Brown translucent J: Colorless and translucent B: Black (K/M connector is only available in black)	Blank: Internal pilot WB: External pilot		Blank: G P: PT T: NPT

#### Order Example:

RV series solenoid valve, 2 series valve body size, standard pilot+Energy saving coil, 5/2 way, single control, 1/4" port size, standard coil, DC24V, DIN connector, G thread, ERP code is: N2R251-08E4

Blank: Patchcord length is 0.3 meter  
0.6M: Patchcord length is 0.6 meter  
1M: Patchcord length is 1 meter  
(Options for "L: Plug-in type" Only)

### Specifications

Model No.	N1R251-M5 N1R252-M5 N1R352-M5	N1R251-06 N1R252-06 N1R352-06	N2R251-06 N2R252-06 N2R352-06	N2R251-08 N2R252-08 N2R352-08	N3R251-08 N3R252-08 N3R352-08	N3R251-10 N3R252-10 N3R352-10	N4R251-10 N4R252-10 N4R352-10	N4R251-15 N4R252-15 N4R352-15
Port size	M5	G1/8	G1/8	G1/4(Ex.G1/8)	G1/4	G3/8(排气G1/4)	G3/8	G1/2
Sectional area(mm <sup>2</sup> )	5/2:5.5(CV=0.31) 5/3:5.5(CV=0.28)	5/2:12(CV=0.67) 5/3:9(CV=0.50)	5/2:14(CV=0.78) 5/3:12(CV=0.67)	5/2:16(CV=0.89) 5/3:12(CV=0.67)	5/2:25(CV=1.40) 5/3:18(CV=1.00)	5/2:30(CV=1.68) 5/3:18(CV=1.00)	5/2:50(CV=2.79) 5/3:30(CV=1.67)	5/2:50(CV=2.79) 5/3:30(CV=1.67)
Working medium	Clean air(After 40 μm filtration)							
Acting type	Internal pilot type / External pilot type							
Reset Type	Air reset				Spring reset /Air reset			
Lubrication	Not required							
Working pressure(MPa)	0.15~0.8							
Guaranteed pressure(MPa)	1.2							
Working temperature(°C)	-20~70(No freezing)							
Voltage range	-15%~10%							
Power consumption	DC24V:0.6W		DC24V:0.7W AC220V:0.9VA AC110V:1.4VA					
Insulation class	Class F							
Protective class	IP65(DIN40050)							
Max. acting frequency	5/2: 5 Cycles/s; 5/3: 3 Cycles/s							
Activate time(S)	<0.05							
Weight(g)	N1R251: 110 N1R252: 171 N1R352: 181	N2R251: 209 N2R252: 314 N2R352: 357	N3R251: 289 N3R252: 400 N3R352: 450	N4R251: 528 N4R252: 638 N4R352: 727				

# RV Series Standard/ Low Power Solenoid Valve (5/2,5/3 way)

## How to Order?

### Standard Solenoid Valve

Series No.	Ways	Positions	Valve Body Size	Controls	Original Status	Port Size	Reset Form	Voltage	Connection Mode	Cover Color	Acting Type	Patchcord	Thread Type
RV	5:5 ways	2: 2 positions 3: 3 positions	1: 1Series 2: 2Series 3: 3Series 4: 4Series	1: Single control 2: Double control	C: Center close P: Center pressure E: Center exhaust (Only for 5/3 way)	M5: M5 06: 1/8" 08: 1/4" 10: 3/8" 15: 1/2"	Blank: Spring Q: Air (Only single control)	E1: AC110V E6: AC36V E2: AC220V E7: AC24V E3: AC380V E8: DC110V E4: DC24V E9: DC48V E5: DC12V E10: DC36V	Blank: DIN connector L: Plug-in Type F: Flying leads K: Waterproof DIN connector (Only 2, 3, 4 series is optional for K/M)	Blank: Brown translucent J: Colorless and translucent B: Black (K/M connector is only available in black)	Blank: Internal pilot WB: External pilot	Blank: Patchcord length is 0.3 meter 0.6M: Patchcord length is 0.6 meter 1M: Patchcord length is 1 meter (Options for "L: Plug-in type" and "F: Flying leads type" Only)	Blank: G P: PT T: NPT

### Order Example:

RV series solenoid valve, 2 series valve body size, 5/2 way, single control, 1/4" port size, standard coil, DC24V, DIN connector, G thread, ERP code is: RV5221-08E4

## Specifications

Model No.	RV5211-M5 RV5212-M5 RV5312-M5	RV5211-06 RV5212-06 RV5312-06	RV5221-06 RV5222-06 RV5322-06	RV5221-08 RV5222-08 RV5322-08	RV5231-08 RV5232-08 RV5332-08	RV5231-10 RV5232-10 RV5332-10	RV5241-10 RV5242-10 RV5342-10	RV5241-15 RV5242-15 RV5342-15
Port size	M5	G1/8	G1/8	G1/4(Ex.G1/8)	G1/4	G3/8(Ex.G1/4)	G3/8	G1/2
Sectional area(mm <sup>2</sup> )	5/2:5.5(CV=0.31) 5/3:5.5(CV=0.28)	5/2:12(CV=0.67) 5/3:9(CV=0.50)	5/2:14(CV=0.78) 5/3:12(CV=0.67)	5/2:16(CV=0.89) 5/3:12(CV=0.67)	5/2:25(CV=1.40) 5/3:18(CV=1.00)	5/2:30(CV=1.68) 5/3:18(CV=1.00)	5/2:50(CV=2.79) 5/3:30(CV=1.67)	5/2:50(CV=2.79) 5/3:30(CV=1.67)
Working medium	Clean air(After 40 μm filtration)							
Acting type	Internal pilot type / External pilot type							
Reset Type	Air reset				Spring reset / Air reset			
Lubrication	Not required							
Working pressure(MPa)	0.15~0.8							
Guaranteed pressure(MPa)	1.2							
Working temperature(°C)	-20~70(No freezing)							
Voltage range	-15%~10%							
Power consumption	DC:2.8W ; AC:3.0VA			DC:3.0W ; AC:4.0VA				
Insulation class	Class F							
Protective class	IP65(DIN40050)							
Max. acting frequency	5/2: 5 Cycles/s; 5/3: 3 Cycles/s							
Activate time(S)	<0.05							
Weight(g)	RV5211: 110 RV5212: 171 RV5312: 181	RV5221: 209 RV5222: 314 RV5322: 357	RV5231: 289 RV5232: 400 RV5332: 450	RV5241: 528 RV5242: 638 RV5342: 727				

## Flow Chat

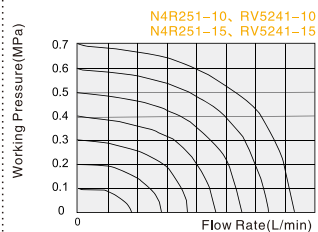
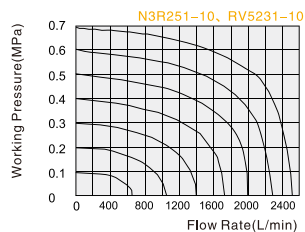
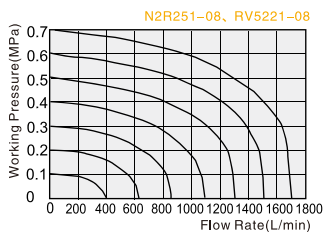
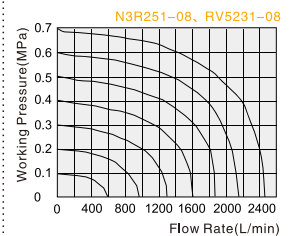
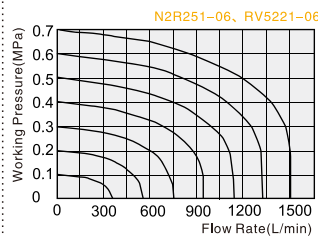
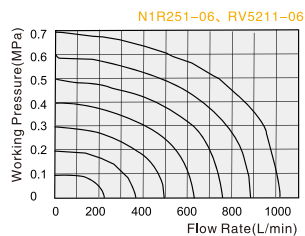
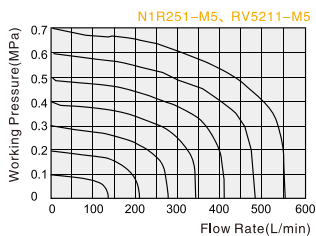

# RV Series Standard/ Low Power Solenoid Valve (5/2,5/3 way)

## Internal Structure

Single Solenoid Valve

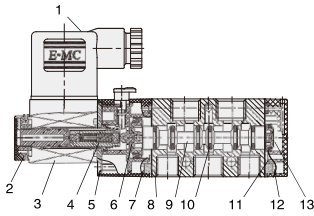

Double Solenoid Valve

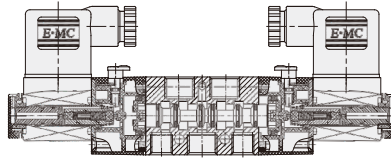

5/3 Solenoid Valve

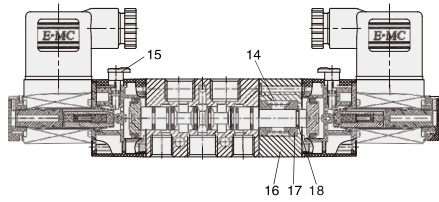

No.	Part Name	Material
1	Connector	Engineered plastics
2	Nut	POM+Carbon steel
3	Coil	Cu
4	Pilot units	Engineered plastics
5	Plate	Carbon steel
6	Piston	POM
7	Pilot seat	Engineered plastics
8	Valve body	Aluminum alloy
9	Spool	Aluminum alloy
10	O-ring	HNBR
11	Rear cover	Engineered plastics
12	Filter	Synthetic material
13	Piston	POM
14	Spring	Stainless steel
15	Manual override	Engineered plastics
16	Back seat	Aluminum alloy
17	Spring seat	Aluminum alloy
18	C-type buckle	65Mn

## Main Dimension

Single Solenoid Valve

DIN Type

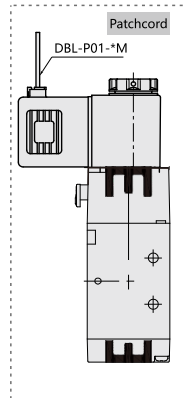
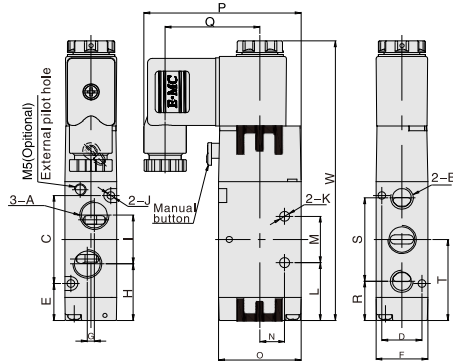

Flying Leads Type

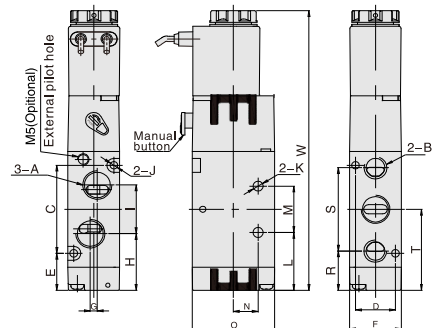

Model/Sign	A	B	C	D	E	F	G	H	I	J	K	L	M	N	O	P	Q	R	S	T	W
RV5211-M5	M5	M5	30	13	16.5	18	0	24.5	14.1	3.3	3.3	24.5	14	9.5	27	55.2	33.9	17.9	27.2	31.5	103.1
RV5211-06	G1/8	G1/8	30	13	16.5	18	3	23.5	16	3.3	3.3	24.5	14	9.5	27	55.2	33.9	17.5	28	31.5	103.1
RV5221-06	G1/8	G1/8	38	17	16	22	0	26	18	3.3	4.3	25	20	10.5	35	66.7	40.2	17	36	35	120.7
RV5221-08	G1/4	G1/8	38	17	16	22	3	24.5	21	3.3	4.3	25	20	10.5	35	66.7	40.2	17	36	35	120.7
RV5231-08	G1/4	G1/4	50	20	19.1	27	0	33.1	22	4.3	4.3	32.1	24	13.5	40	69.2	40.2	21.6	45	44.1	139.3
RV5231-10	G3/8	G1/4	50	20	19.1	27	4	32.1	24	4.3	4.3	32.1	24	13.5	40	69.2	40.2	21.6	45	44.1	139.3
RV5241-10	G3/8	G3/8	72	27	21	34	0	39	36	4.3	5.5	43	28	17.5	50	74.2	40.2	25.5	63	57	168.7
RV5241-15	G1/2	G1/2	72	27	21	34	4	39	36	4.3	5.5	43	28	17.5	50	74.2	40.2	25.5	63	57	168.7

Note: The dimensions of NR series and RV series are same.

Double Solenoid Valve

5/3 Solenoid Valve

DIN Type

Flying Leads Type

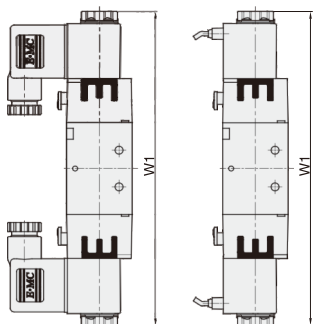

DIN Type

Flying Leads Type

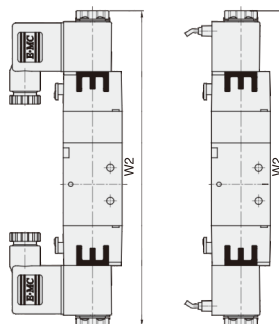

Model/Sign	W1
RV5212-M5	143.2
RV5212-06	143.2
RV5222-06	171.4
RV5222-08	171.4
RV5232-08	190.4
RV5232-10	190.4
RV5242-10	223.4
RV5242-15	223.4

Model/Sign	W2
RV5312-M5	158.2
RV5312-06	158.2
RV5322-06	190.4
RV5322-08	190.4
RV5332-08	209.4
RV5332-10	209.4
RV5342-10	244.4
RV5342-15	244.4

Note: The dimensions of NR series and RV series are same.

# RV Series Standard/ Low Power Solenoid Valve (3/2 way)

## RV

### Standard/ Low Power Solenoid Valve (3/2 way)

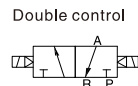
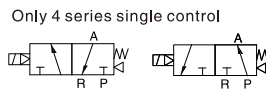
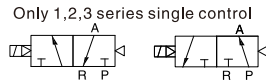

### How to Order?

#### Low Power Solenoid Valve

Series	Valve body size	ID code	Positions	Ways	Controls	Original Status	Port Size	Reset Type	Voltage	Connection Mode	Cover Color	Acting Type	Patchcord	Thread Type
N	1: 1Series 2: 2Series 3: 3Series 4: 4Series		2: positions	3: 3 ways	1: Single control 2: Double control	Blank: Normal close H: Normal open	M5: M5 06: 1/8" 08: 1/4" 10: 3/8" 15: 1/2"	Blank: Spring (4 series single control only) Q: Air (1,2,3 series single control)	E1: AC110V E2: AC220V E4: DC24V (for 1series, only DC24V available)	Blank: DIN connector type L: Plug-in Type K: Water proof connector type (only for 2,3,4 series)	Blank: Brown translucent J: Colorless and translucent B: Black (Only black color available for water proof connector)	Blank: Internal pilot WB: External pilot	Blank: Patchcord length is 0.3 meter 0.6M: Patchcord length is 0.6 meter 1M: Patchcord length is 1 meter (Options for "L: Plug-in type" Only)	Blank: G P: PT T: NPT
	R: Standard armature + Energy saving coil													

#### Order Example:

RV series energy saving solenoid valve, 2 series valve body size, 3/2 ways, double control, 1/8" port size, AC220V, DIN connector, G thread, ERP code is :N2R232-06E2

### Specifications

Model No.	N1R231-M5 N1R232-M5	N1R231-06 N1R232-06	N2R231-06 N2R232-06	N2R231-08 N2R232-08	N3R231-08 N3R232-08	N3R231-10 N3R232-10	N4R231-10 N4R232-10	N4R231-15 N4R232-15
Port size	M5	G1/8	G1/8	G1/4	G1/4	G3/8	G3/8	G1/2
Sectional area(mm)	5.5(CV=0.31)	12(CV=0.67)	14(CV=0.78)	16(CV=0.89)	25(CV=1.40)	30(CV=1.68)	50(CV=2.79)	50(CV=2.79)
Working medium	Clean air(After 40 μm filtration)							
Acting type	Internal pilot type/External pilot type							
Reset type	Air reset						Spring reset /Air reset	
Lubrication	Not required							
Working pressure(MPa)	0.15-0.8							
Guaranteed pressure(MPa)	1.2							
Working temperature(°C)	-5~60(No freezing)							
Voltage range	-15%~10%							
Power consumption	DC24V:0.6W		DC24V:0.7W AC220V:0.9VA AC110V:1.4VA					
Insulation class	Class F							
Protective class	IP65(DIN40050)							
Max. acting frequency	5 Cycles/s							
Activate time(S)	<0.05							
Weight(g)	N1R231: 102 N1R232: 169		N2R231: 107 N2R232: 303		N3R231: 260 N3R232: 370		N4R231: 443 N4R232: 569	

Note: Normal open is same as normal close.

# RV Series Standard/ Low Power Solenoid Valve (3/2 way)

## How to Order?

### Standard Solenoid Valve

Series No.	Ways	Positions	Valve Body ID Code	Controls	Original Status	Port Size	Reset Type	Voltage	Connection Mode	Cover Color	Valve Color	Patchcord	Thread Type
RV	2: 2 ways 3: 3 ways	2: 2 positions	1: 1Series 2: 2Series 3: 3Series 4: 4Series	1: Single control 2: Double control	Blank: Normal close H: Normal open	M5: M5 06: 1/8" 08: 1/4" 10: 3/8" 15: 1/2"	Blank: Spring (Only 4 series single control) Q: Air (1,2,3 series single control)	E1: AC110V E6: AC36V E2: AC220V E7: AC24V E3: AC380V E8: DC110V E4: DC24V E9: DC48V E5: DC12V E10: DC36V	Blank: DIN connector L: Plug-in Type F: Flying leads K: Waterproof DIN connector (Only 2, 3, 4 series is optional for K/M)	Blank: Brown translucent J: Colorless and translucent B: Black (Only Waterproof DIN connector)	Blank: Internal pilot WB: External pilot	Blank: Patchcord length is 0.3 meter 0.6M: Patchcord length is 0.6 meter 1M: Patchcord length is 1 meter (Options for "L: Plug-in type" and "F: Flying leads type" Only)	Blank: G P: PT T: NPT

### Order Example:

RV series solenoid valve, 2 series valve body size, 3/2 ways, single control, 1/8" port size, air return, standard coil, AC220V, DIN connector, G thread, ERP code is :RV3221-06QE2

## Specifications

Model No.	RV3211-M5 RV3212-M5	RV3211-06 RV3212-06	RV3221-06 RV3222-06	RV3221-08 RV3222-08	RV3231-08 RV3232-08	RV3231-10 RV3232-10	RV3241-10 RV3242-10	RV3241-15 RV3242-15
Port size	M5	G1/8	G1/8	G1/4	G1/4	G3/8	G3/8	G1/2
Sectional area(mm)	2 way: 5.5(CV=0.31)	2 way: 12(CV=0.67)	2 way: 14(CV=0.78)	2 way: 16(CV=0.89)	2 way: 25(CV=1.40)	2 way: 30(CV=1.68)	2 way: 50(CV=2.79)	2 way: 50(CV=2.79)
Working medium	Clean air(After 40 μm filtration )							
Acting type	Internal pilot type/External pilot type							
Reset type	Air reset						Spring reset /Air reset	
Lubrication	Not required							
Working pressure(MPa)	0.15~0.8							
Guaranteed pressur(MPa)	1.2							
Working temperature(°C)	-5~70(No freezing)							
Voltage range	-15%~10%							
Power consumption	DC:2.8W ; AC:3.0VA			DC:3.0W ; AC:4.0VA				
Insulation class	Class F							
Protective class	IP65(DIN40050)							
Max. acting frequency	5 Cycles/s							
Activate time(S)	<0.05							
Weight(g)	RV3211: 102 RV3212: 169	RV3221: 107 RV3222: 303	RV3231: 260 RV3232: 370	RV3241: 443 RV3242: 569				

## Flow Chat

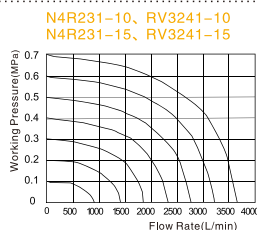
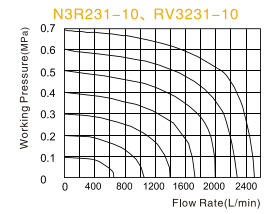
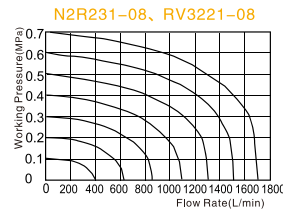
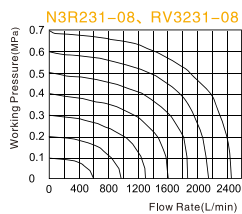
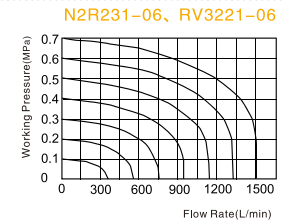
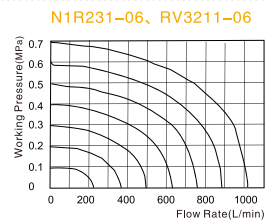
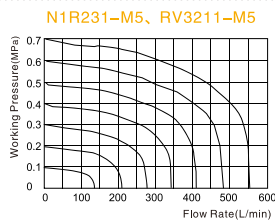

# RV Series Standard/ Low Power Solenoid Valve (3/2 way)

## Internal Structure

Single Solenoid Valve(Normal close)

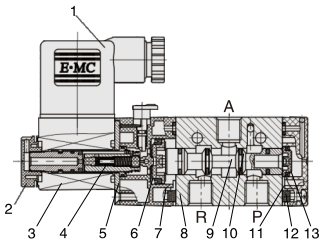

Single Solenoid Valve(Normal open)

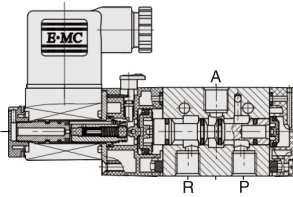

Double solenoid valve(Normal close)

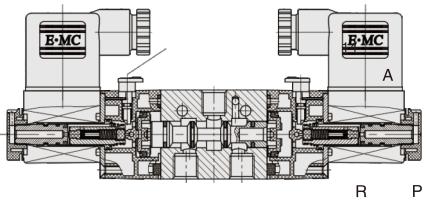

No.	Part Name	Material
1	Connector	Engineered plastics
2	Nut	POM
3	Coil	Cu+ Thermosetting resin
4	Pilot units	Pure iron + copper + stainless steel
5	Plate	Carbon steel
6	Piston	POM
7	Pilot seat	Engineered plastics
8	Valve body	Aluminum alloy
9	Spool	Aluminum alloy
10	O-ring	NBR
11	Rear cover	Engineered plastics
12	Filter	Synthetic material
13	Piston	Engineered plastics
14	Manual button	Engineered plastics

## Main Dimension

### Single Solenoid Valve

### Double Solenoid Valve

DIN Type

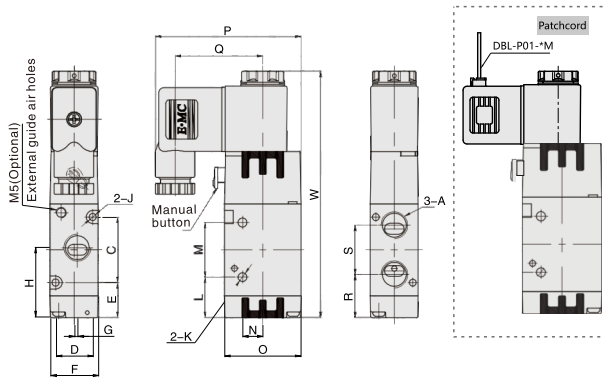

Flying Leads Type

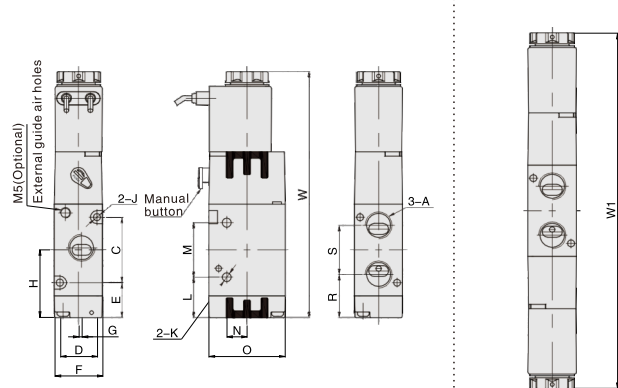

(mm)

Model/Sign	A	C	D	E	F	G	H	J	K	L	M	N	O	P	Q	R	S	W	W1*
RV3211-M5	M5	19	13	16.5	18	0	26	3.3	3.1	15.5	21	6	27	55.2	33.9	18.9	14.2	92.1	132.2
RV3211-06	G1/8	19	13	16.5	18	1.5	27	3.3	3.1	15.5	21	6	27	55.2	33.9	18	16	92.1	132.2
RV3221-06	G1/8	30	17	16	22	0	31	3.3	4.2	18.5	25	9.3	35	66.7	40.2	20	22	112.7	163.4
RV3221-08	G1/4	30	17	16	22	1.5	32	3.3	4.2	18.5	25	9.3	35	66.7	40.2	19.8	22.5	112.7	163.4
RV3231-08	G1/4	35	20	19.1	27	0	36.6	4.3	4.3	21.6	30	9.5	40	69.2	40.2	24.6	24	124.3	175.4
RV3231-10	G3/8	35	20	19.1	27	2	36.6	4.3	4.3	21.6	30	9.5	40	69.2	40.2	24.6	24	124.3	175.4
RV3241-10	G3/8	40.5	27	24.8	34	0	45	4.3	5.2	21	48	11.5	50	74.2	40.2	29.3	31.5	144.7	199.4
RV3241-15	G1/2	40.5	27	24.8	34	2	45	4.3	5.2	21	48	11.5	50	74.2	40.2	29.3	31.5	144.7	199.4

Note: The dimension of NR series and RV series are same, The dimension of normal open type and normal close type are same, W1\* is the dimension of double control solenoid valve.